

EPDS



EXPAND Control

Meeting Room Controller & Scheduling Panel

User Guide

Model: DSWBT2

Contents

Welcome	2
Package contents	3
EXPAND Control at a glance	4
Tablet at a glance	4
LEDs at a glance	5
Installing the EXPAND Control	7
Taking off the bottom cover	7
Installation options	8
A Placing the product on a desk	9
B Mounting the product on a wall	10
C Mounting the product on a desk	12
Connecting to Ethernet for power supply	14
Using an optional Kensington® lock	15
Setting up the EXPAND Control	16
Making the tablet work as a Scheduling Panel	16
Making the tablet work as a Meeting Room Controller	17
Using as Meeting Room Controller	18
Standby mode & waking up	18
Joining meetings / calls	19
Changing the volume	20
Muting / unmuting the microphone	20
Using as Scheduling Panel	21
Checking room availability and meeting details	21
Reserving an available room on a spot	22
Maintaining & updating the product	23
Changing the EXPAND Control settings	23
Updating the firmware	23
Cleaning the product	24
If a problem occurs	25

Welcome

One-touch Control

The EXPAND Control tablet serves as either a meeting room controller or a scheduling panel, seamlessly integrating with leading UC solutions for any meeting room.

Hassle-free installation and flexible tidy mounting options deliver an intuitive user experience that drives fast deployment and adoption.

Using the tablet as a meeting room controller, it easily pairs with EPOS EXPAND Vision video conferencing solutions, providing frictionless meetings.

Features include one-touch join, adjust call settings, or share content using the large anti-glare screen with its ergonomic viewing angle. Using it as a wall-mounted scheduling panel, users can view location and meeting details and reserve available meeting spaces on the spot. Multi-colored LED indicators on the side of the tablet show available meeting rooms.

Certified for leading UC solutions including Microsoft Teams Rooms on Android and Zoom Rooms, the tablet can be configured and managed remotely.

Scandinavian simplicity meets functionality making it subtle but flexible addition to any meeting room set up.

Key benefits & features

Enhanced meeting control

The tablet serves as either a meeting room touch controller or scheduling panel, which seamlessly integrates with leading UC solutions, providing a superior meeting experience

Superior user-experience

Designed for an outstanding and ergonomic user experience, the tablet has an optimal viewing angle and a large 10.1" anti-glare treated touch screen

Adapts to all meeting spaces

Suitable for any meeting room size or type, it also supports EPOS EXPAND Vision video conferencing solutions



Flexible and tidy setup



Multiple mounting options, integrated cable retention and a single Power over Ethernet cable ensure an optimal and clean installation

Certified solution

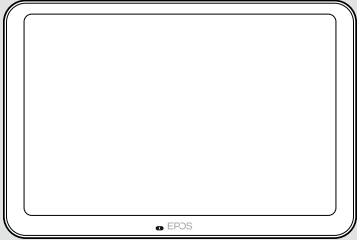
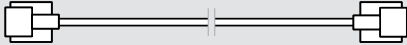
Certified for leading UC solutions including Microsoft Teams Rooms on Android™ and Zoom Rooms, it delivers a flawless user experience and comes with a trusted stamp of approval

Package contents

	<p>EXPAND Control Tablet</p>
	<p>Ethernet cable Power over Ethernet (PoE) and network access RJ45 to RJ45</p>
	<p>Quick Guide Safety Guide Compliance sheet</p>

	<p>For safety instructions, consult the Safety Guide.</p>
	<p>For specifications, consult the Fact sheet available at eposaudio.com</p>

Trademarks

The Bluetooth® word mark and logos are registered trademarks owned by Bluetooth SIG, Inc. and any use of such marks by DSEA A/S is under license.

Kensington is a registered trademark of ACCO Brands. Kensington The Professionals' Choice is a trademark of ACCO Brands. All other trademarks are the property of their respective owners.

EXPAND Control at a glance

Tablet at a glance

FRONT

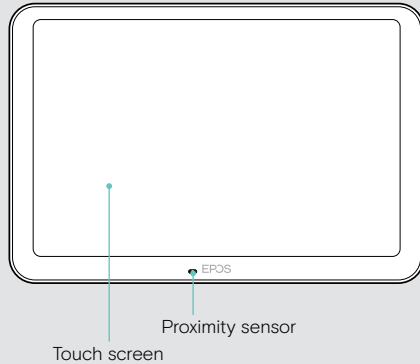

SIDE

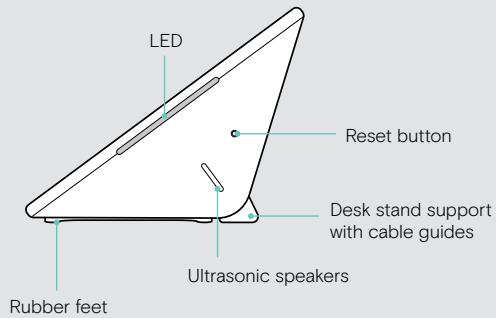

BOTTOM

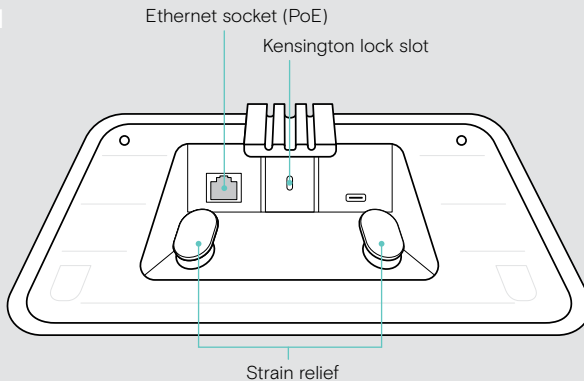

LEDs at a glance

As the EXPAND Control can be used as a Meeting Room Controller or Scheduling Panel (e.g. at the door, outside the meeting room), it offers different LED indications.

LED indications of the Meeting Room Controller

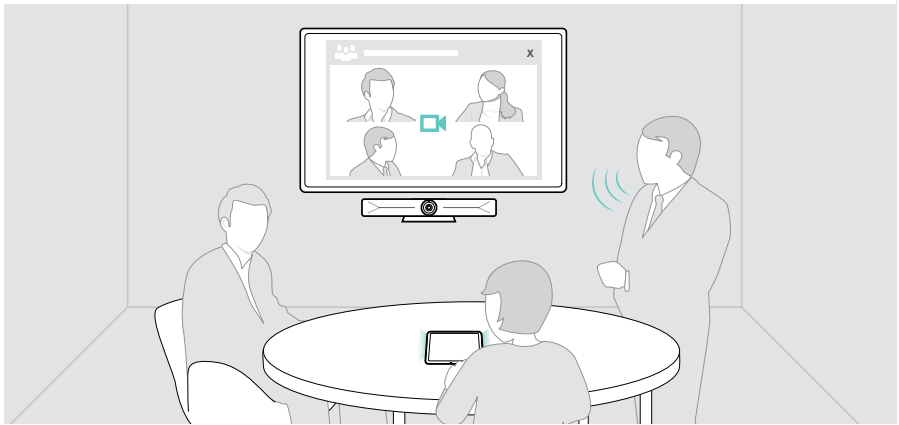
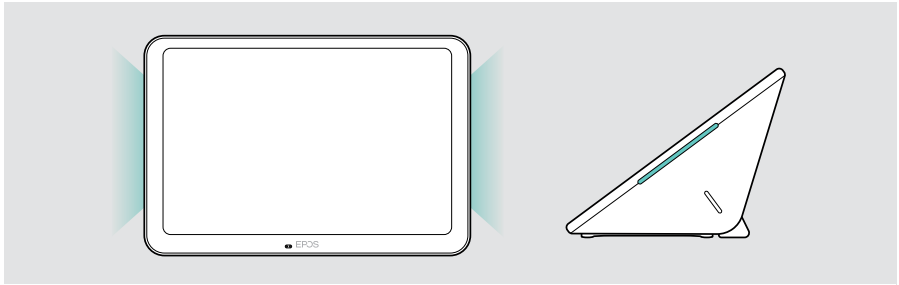

Tablet active (e.g. in a call)



Tablet in standby mode

LED indications of the Scheduling Panel

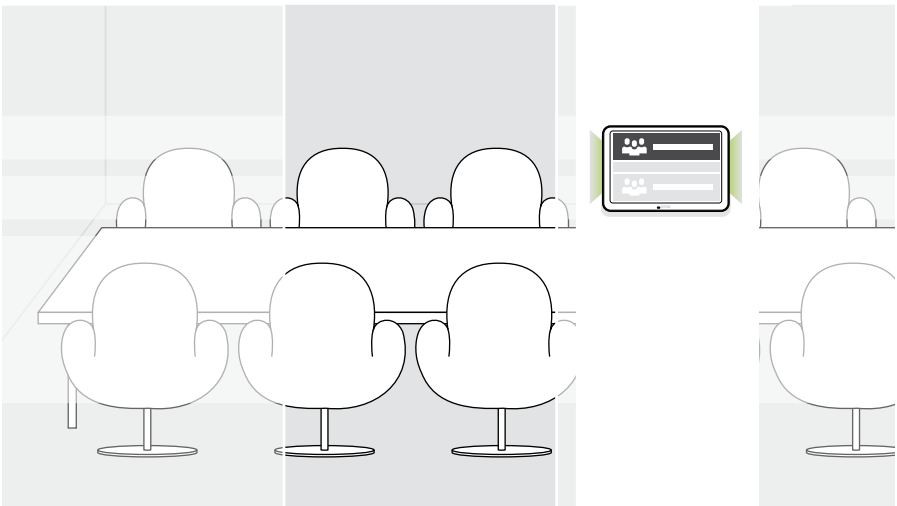
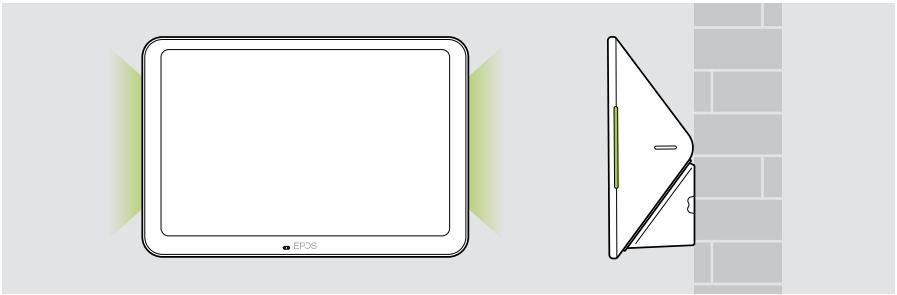

 Status: occupied / not available

 Status: free / available

Installing the EXPAND Control

Taking off the bottom cover

The connectors are located under the bottom cover.

- 1 Remove the two screws with a cross-head screwdriver.
- 2 Take off the cover.

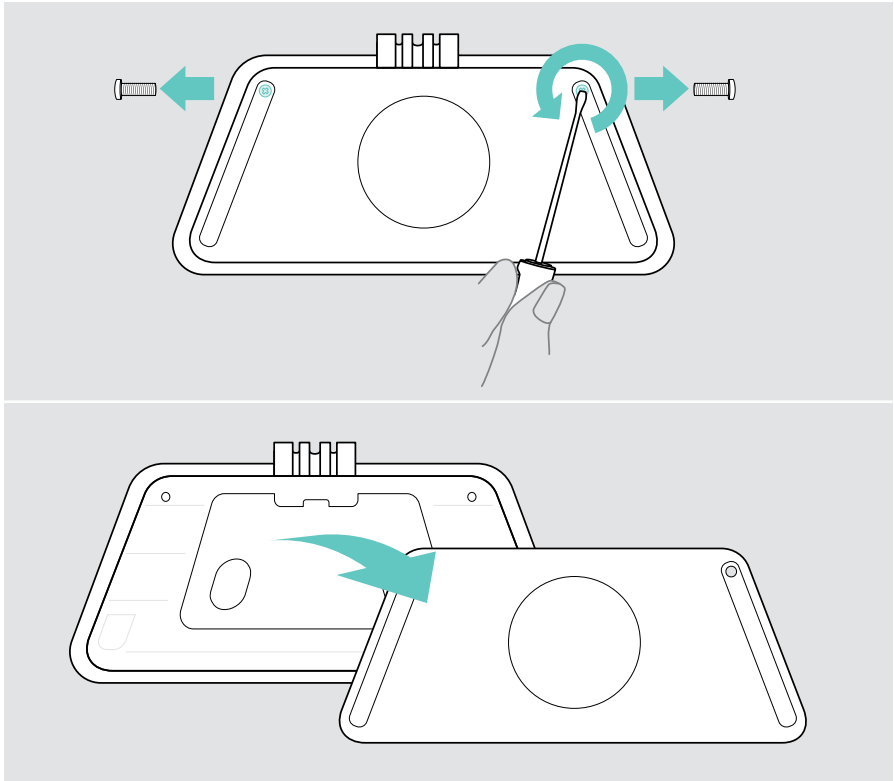

Installation options

As the EXPAND Control can be used as a Meeting Room Controller or Scheduling Panel (e.g. at the door, outside the meeting room), there are several installation options.

The tablet can be:

- **A** Simply placed on a desk,
- **B** Mounted on a wall e.g. at the door / room entrance (accessory: Control - WM 01)
- **C** Fixed mounted on a desk (accessory: Control - DM 01)

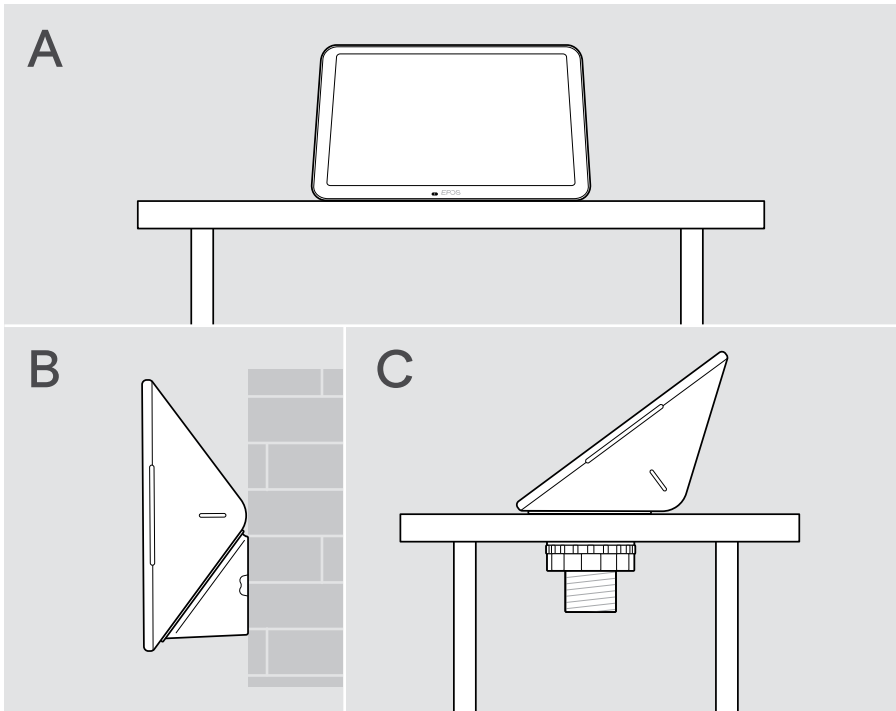

A Placing the product on a desk

- > Connect the Ethernet cable (see page 14) and potentially an optional Kensington lock (see page 15).
- > Press the cables into the cable guides to secure them.
- > Put on the bottom cover and secure it with the two securing screws.
- > Place the tablet on your desk.

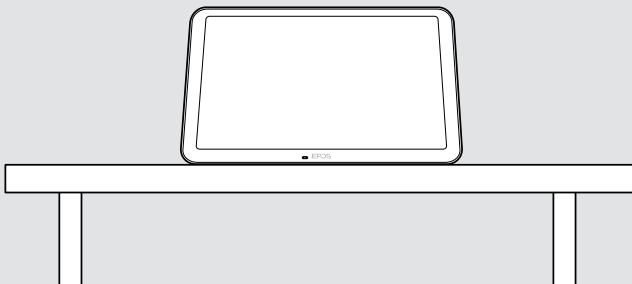
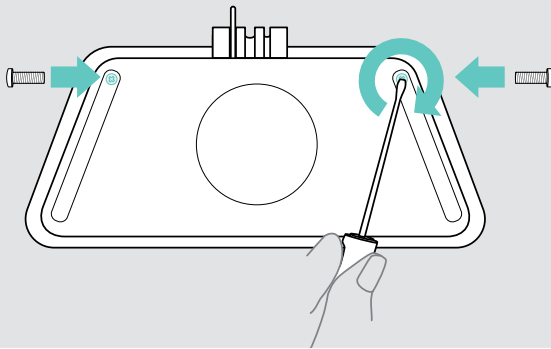
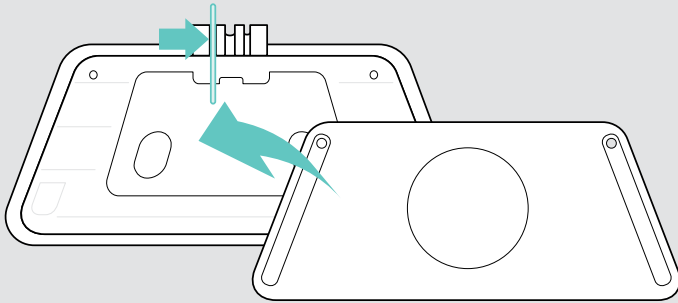
A

B Mounting the product on a wall



CAUTION

Danger of accidents or damages!

Drilling into e.g. cables and can lead to accidents.

- > Check whether there are any cables or pipes in the wall.

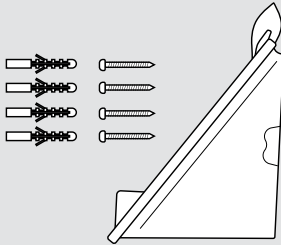

To mount the tablet on a wall:

- > Use the [Control - WM 01](#) accessory.

Package contents:

- Wall mount cover
- Dowels*
- Dowel screws

*differing wall types may require specific dowels

The wall type is an example - other wall types may require different mounting.

- 1 Pull down the desk stand support to remove it.
- 2 Choose a position so that the **tablet is easily accessible**. Hold the wall mount cover against the wall, balance it and add four marks.

B

1

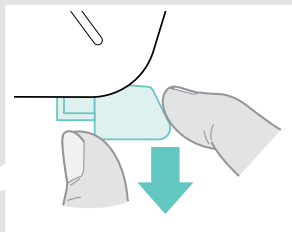
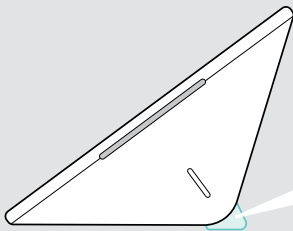

2

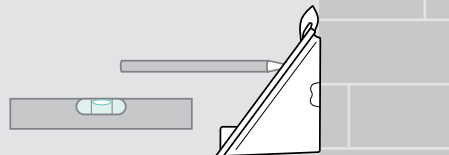
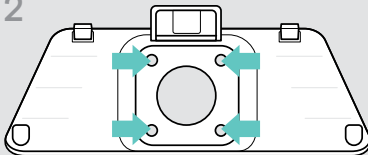

- 3 Drill four holes and insert the dowels.
- 4 Hold the wall mount cover against the wall and fix it with the screws.
- 5 Connect the Ethernet cable (see page 14). Feed the cables through the wall mount's hole. Slide in the tablet and tighten the two screws.

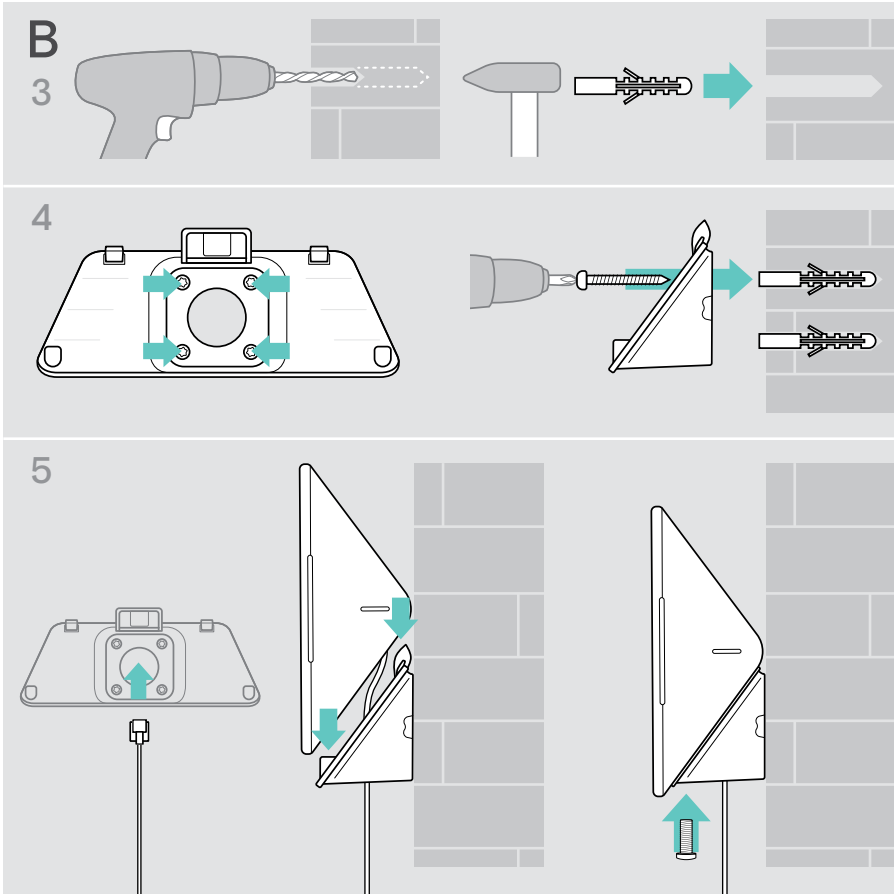

C Mounting the product on a desk

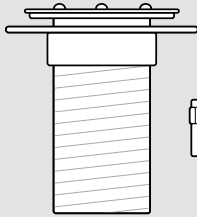

To mount the tablet fixed on a desk:
> Use the **Control - DM 01** accessory.

Package contents:

- Table top mount
- Locking nut

- 1 Remove the 4 hexagon socket screws at the table top mount to loosen the mounting plate.
- 2 Remove the round cover from the tablet's bottom cover.
- 3 Insert the table top mount into the tablet's bottom hole and fix the mounting plate with the 4 screws on top.

C

1

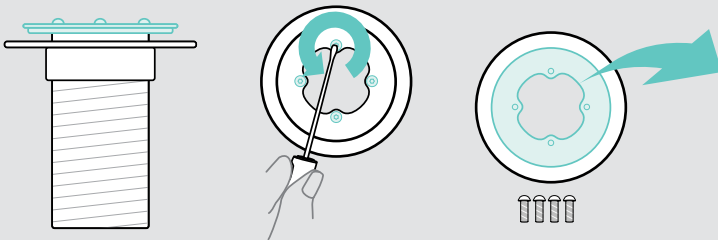

2

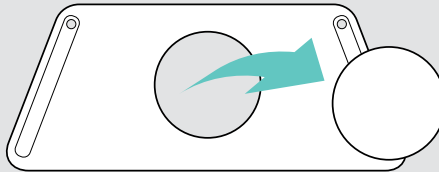

3

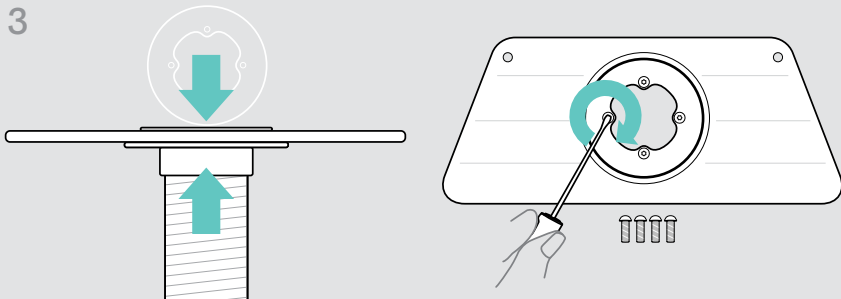

- 4 Pull down the desk stand support to remove it.
- 5 Connect the Ethernet cable (see page 14) and potentially an optional Kensington lock (see page 15) with the tablet. Feed the cables through the table top mount.
- 6 Put on the bottom cover and tighten the two screws.
- 7 Insert the table top mount in your desk's hole and screw on the locking nut.

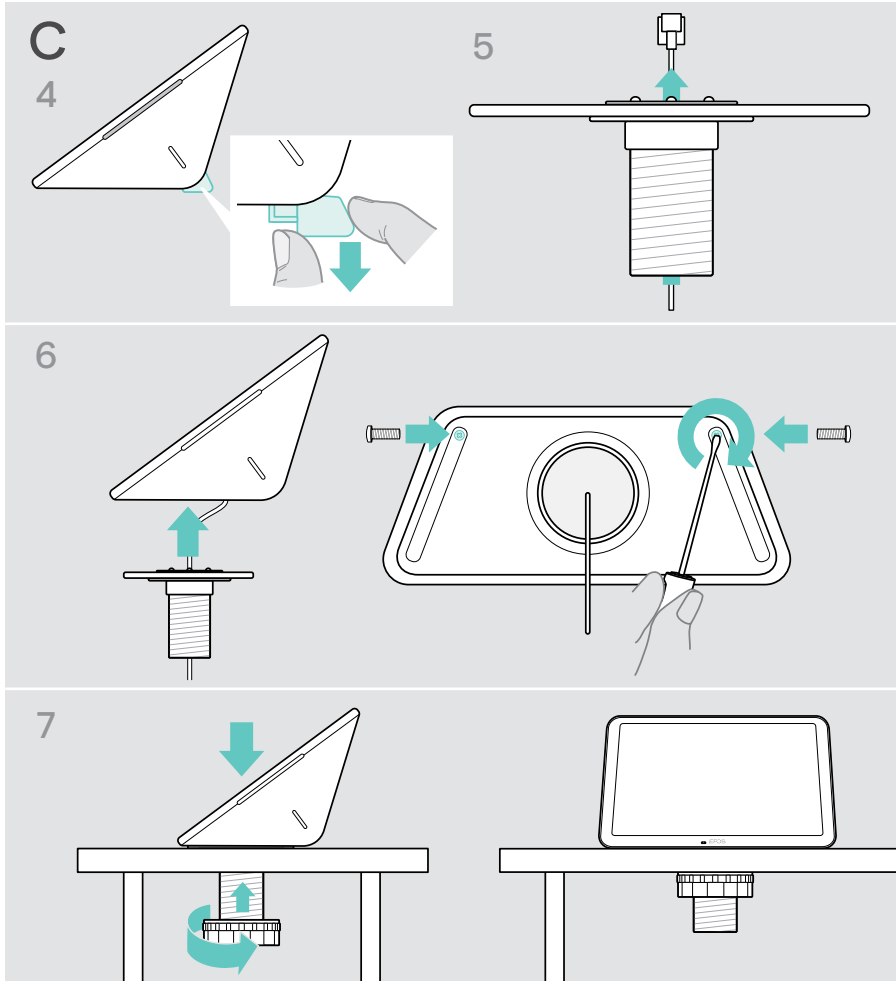

Connecting to Ethernet for power supply

- 1 Connect the Ethernet cable to the tablet's Ethernet socket and a RJ45 socket that provides PoE (Power over Ethernet).
The screen switches on and the LEDs light up in a dimmed mint. If you use the EXPAND Control for the first time, the setup wizard appears (see page 16).
- 2 Loop the cable around the strain relief.

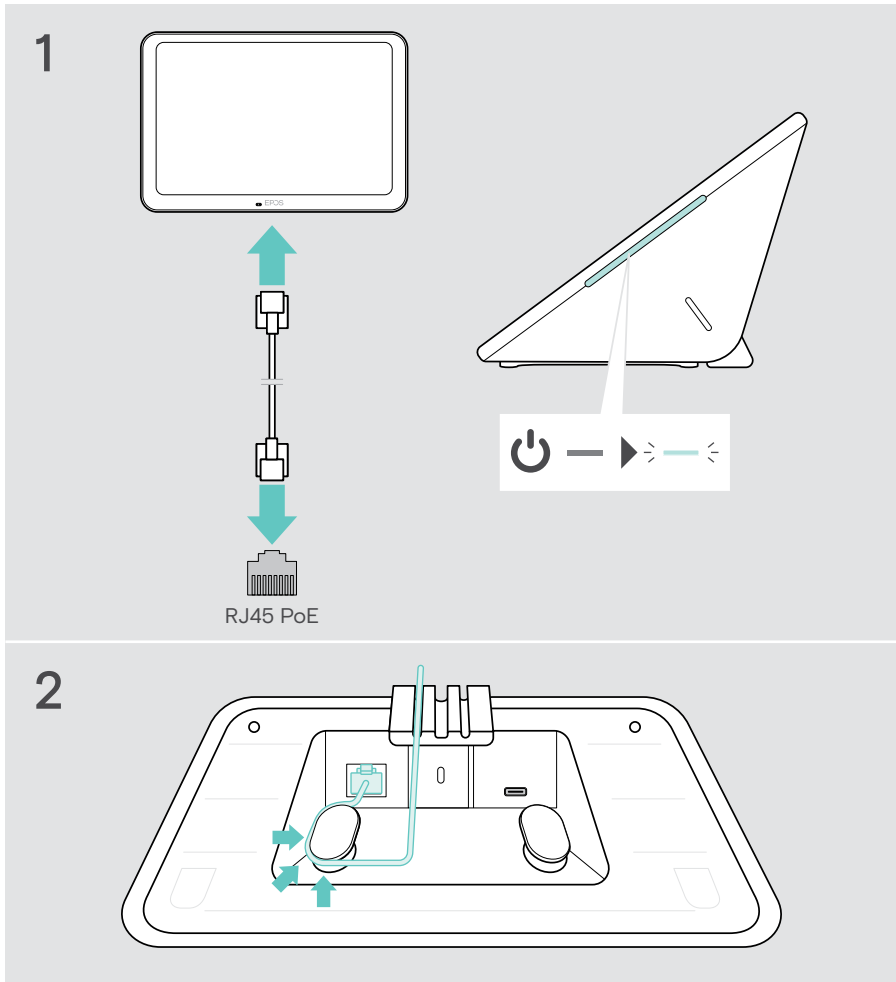

Using an optional Kensington® lock

You can secure your tablet e.g. on a meeting room table with an optional Kensington lock. The Kensington slot supports most common Kensington locks.

- > Follow the instructions for your Kensington lock.

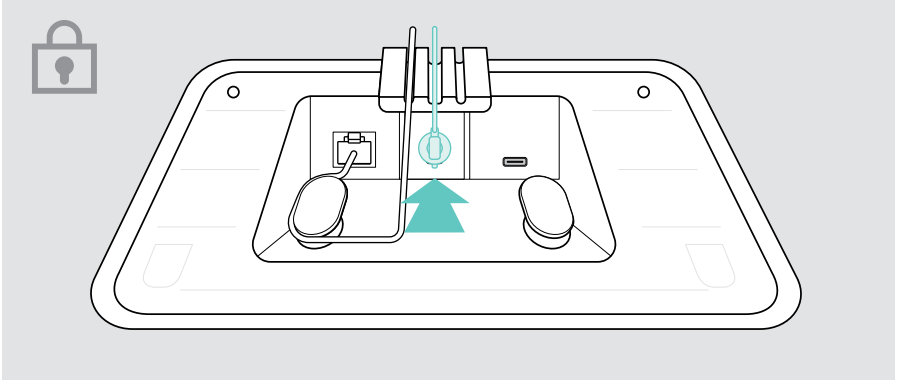

Setting up the EXPAND Control

As soon as the EXPAND Control is connected to the Ethernet, the setup wizard appears if you use it for the first time.

- > Follow the tablet's wizard to connect UC solutions, UC devices and change the settings to your needs.

During the setup you will be asked if you want to use the tablet as a [Meeting Room Controller](#) "Touch Console" or [Scheduling Panel](#) "Panels", see following chapters.



Making the tablet work as a Scheduling Panel

- > Follow the wizard to make the tablet work as a Scheduling Panel and connect it with your UC solution (e.g. Zoom, Microsoft Teams).

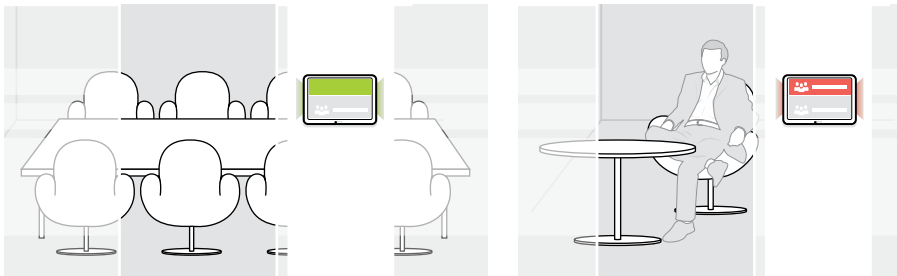

Making the tablet work as a Meeting Room Controller

To use the tablet as a Meeting Room Controller, you need to connect it to your e.g. EPOS EXPAND Vision 5 or Vision 3T Collaboration bar.

- > Install and connect to the EXPAND Vision 5 or Vision 3T Collaboration bar before you start the setup.
- > Follow the wizard to connect your EXPAND Vision product either via Bluetooth or the Ultrasonic speakers (UC solution dependent).

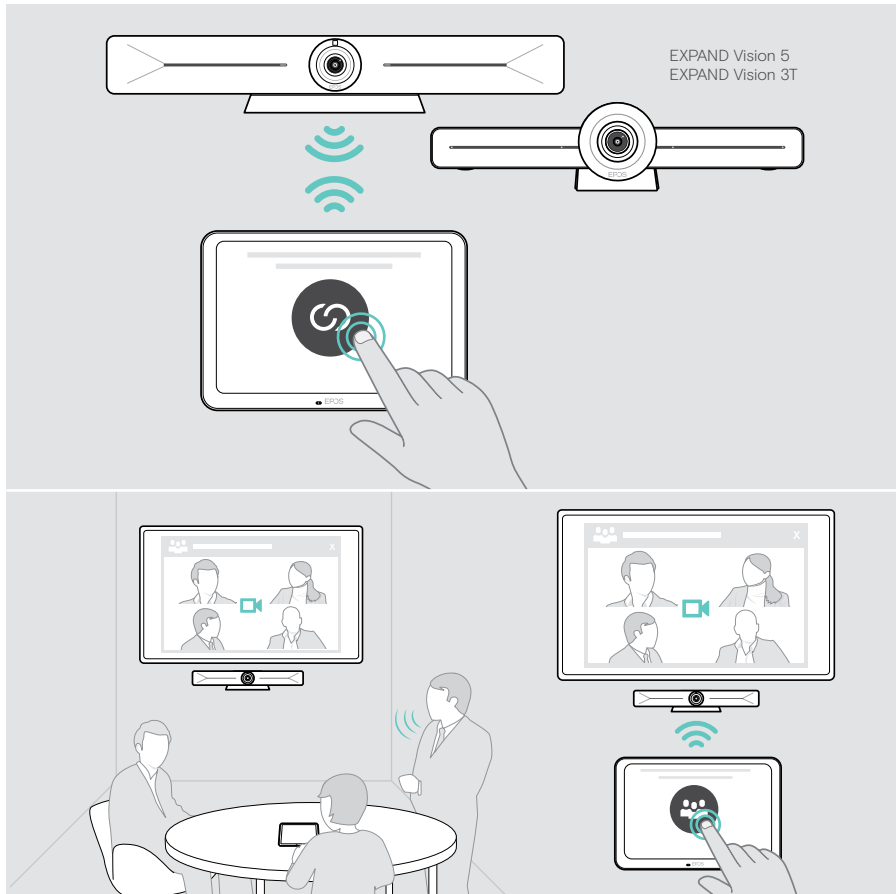

Using as Meeting Room Controller

With the tablet's touch screen, you can control your EPOS EXPAND Vision 5 or Vision 3T collaboration bar, for example:

- Join and control meetings (one-touch join),
- Adjust call settings, change the volume, mute the microphone or
- Share content (EXPAND Vision 5).

Standby mode & waking up

The tablet turns on automatically as soon as it is connected to power.

To save energy, the tablet turns to standby mode when the proximity sensor detects no activity in the meeting room. The screen is switched off and the LEDs changed to a dimmed mint.

If the proximity sensor recognizes a movement in the room, the tablet wakes up automatically. The screen switches on and the LEDs light up in a bright mint.

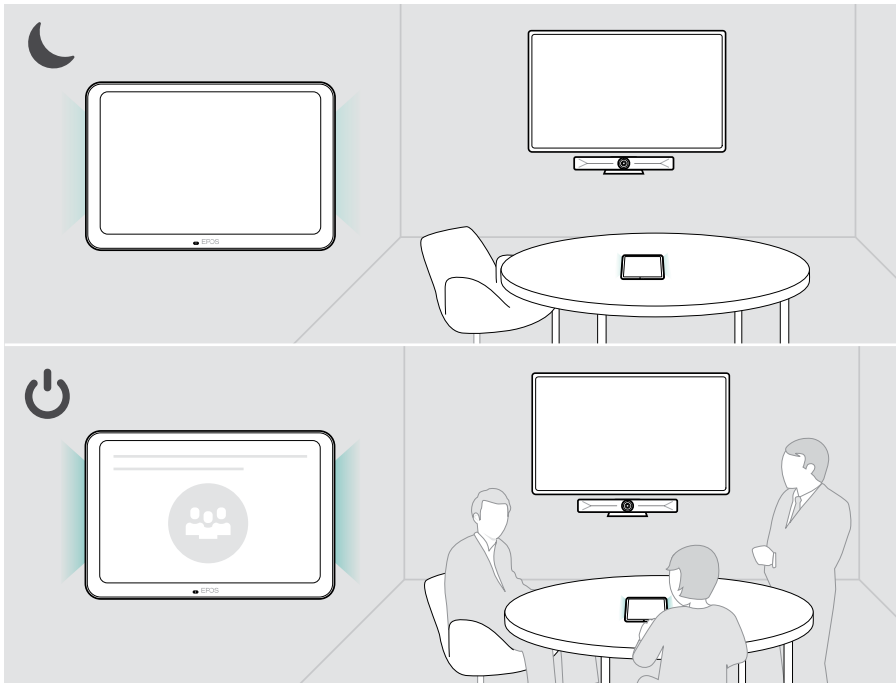

Joining meetings / calls

You can join and control meetings and calls via your UC solution (e.g. Zoom, Microsoft Teams) and the EXPAND Control.

- > Touch the join or meet button or icon to join your meeting.

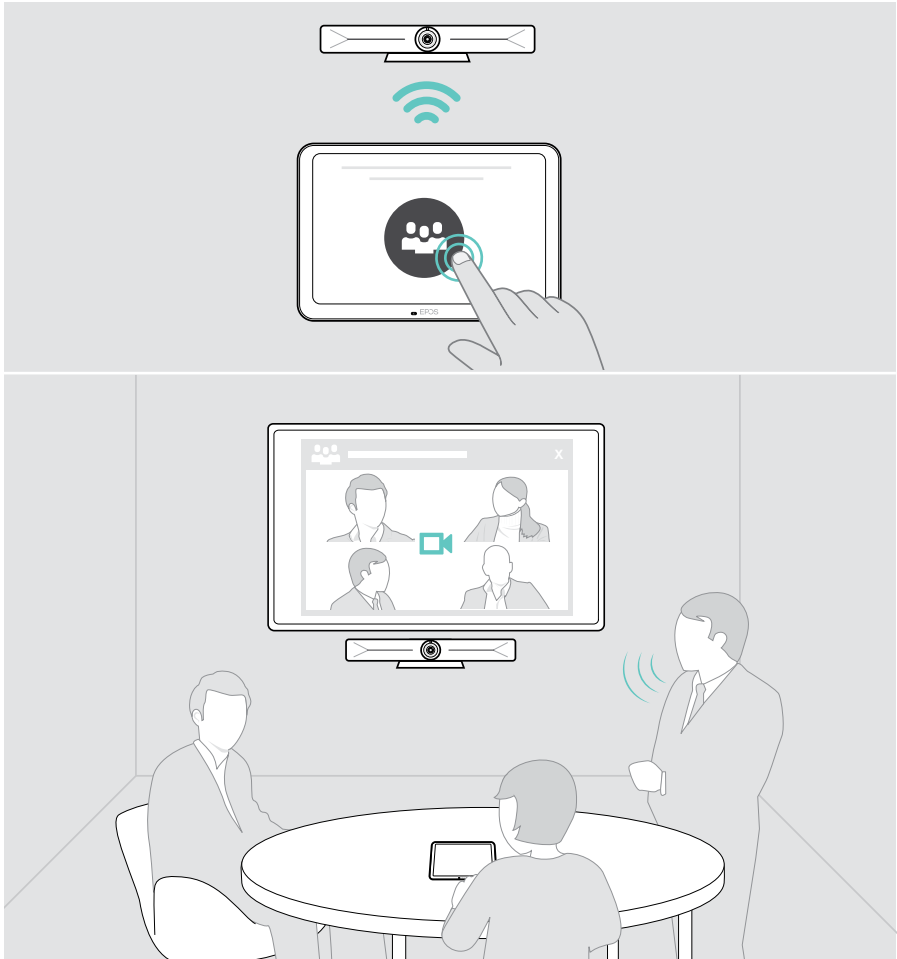

Changing the volume



CAUTION

Risk of hearing damage!

Listening at high volume levels for long periods can lead to permanent hearing defects.

- > Do not continuously expose yourself to high volumes.

To change the volume while you are in a meeting:

- > Touch the icon + or - to increase or reduce the volume of your connected speakers (e.g. EXPAND Vision 5 or connected speakerphone for Vision 3T).



Muting / unmuting the microphone

To mute or unmute the microphones of your connected device during a meeting:

- > Touch the mute icon.

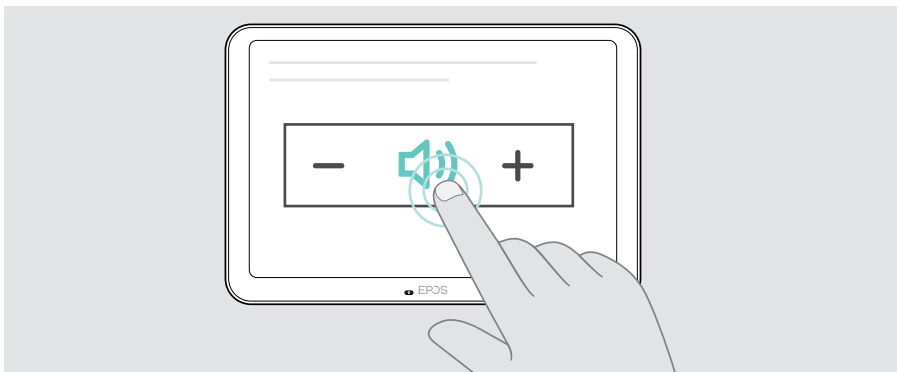

Using as Scheduling Panel

When using the tablet as Scheduling Panel, you can for example:

- View location and meeting details or
- Reserve available meeting rooms on the spot.

Checking room availability and meeting details

If you are looking for a room for an instant meeting:

- > Take a look at the meeting room corridor. The LEDs indicate if a meeting room is available:

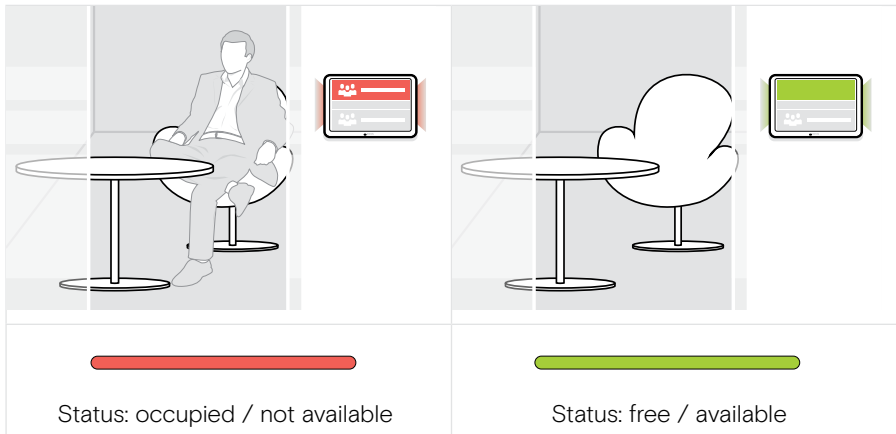

On the screen you can find all meetings with several details scheduled for this day. The information on the screen is provided via the Ethernet connection and your UC solution (e.g. Zoom, Microsoft Teams).

Reserving an available room on a spot

If the room is available, you can make a reservation for an instant meeting:

- > Touch on e.g. “Reserve” (UC solution dependent).
- > Choose a time slot.
The LEDs turn red.

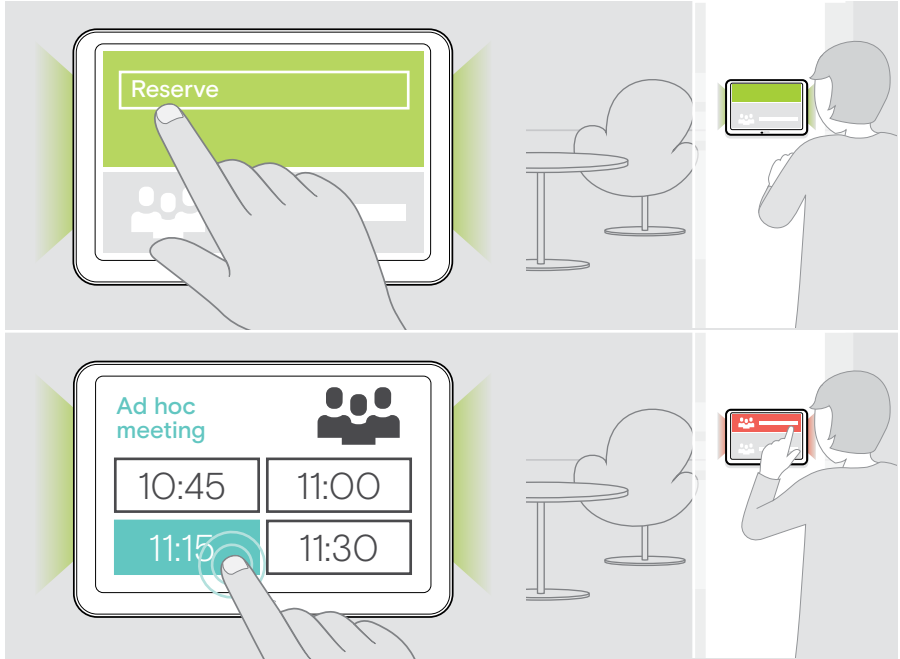

Maintaining & updating the product

Changing the EXPAND Control settings

The on screen settings menu is used for personalizing the device.

> Touch on “... More” > “Settings” to change the setting.

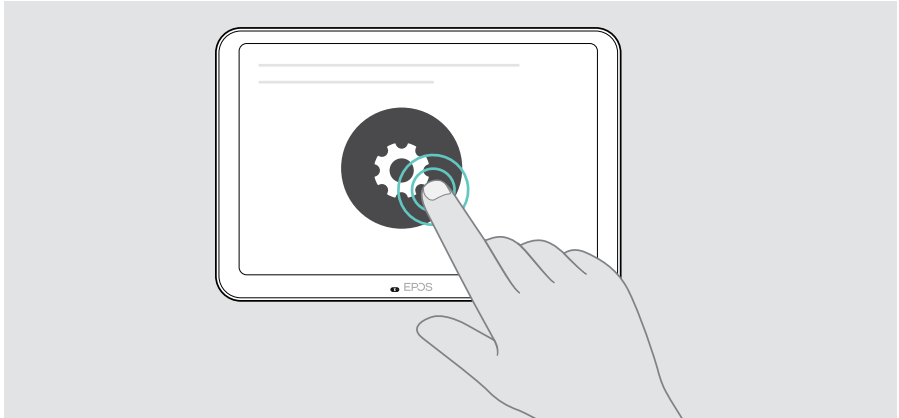

The Admin settings are password protected.

Updating the firmware

Updates for the EXPAND Control will be made available through your UC solution and will be downloaded and installed automatically – once enabled by the IT-administrator.

Cleaning the product

CAUTION

Liquids can damage the electronics of the product!

Liquids entering the housing of the device can cause a short circuit and damage the electronics.

- > Keep all liquids far away from the product.
- > Do not use any cleansing agents or solvents.

- > Use a dry cloth to clean the product only.

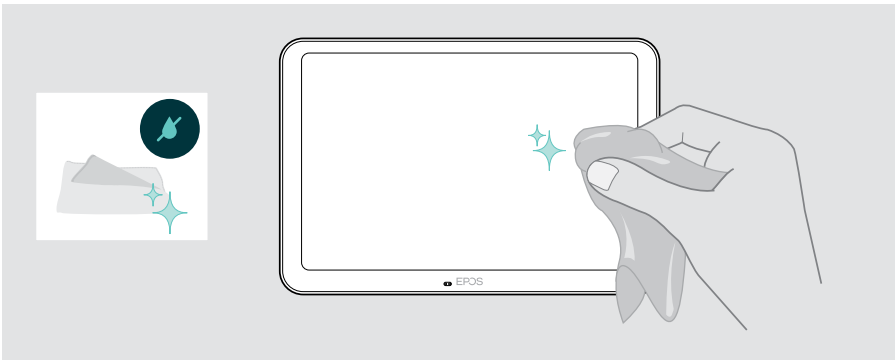

If a problem occurs...

Problem	Possible cause	Solution	Page
No connection	PoE cable is not inserted correctly (LEDs off)	> Check the cable connection.	14
	RJ 45 socket does not support PoE	> Use a PoE adapter as power supply and WiFi.	–
Call can not be established	Firewall is blocking the call	> Check and change the network firewall settings.	–
No audio	Microphones muted	> Unmute the microphones via the tablet or your connected device.	20
Controller/ Panel does not respond	Tablet has experienced an unexpected error	1 Restart the tablet.	26
		2 Reset the tablet.	27
Change of use case	Swap function of Meeting Room Controller and Scheduling Panel	> Contact our customer support.	–

If a problem occurs that is not listed here or if the problem cannot be solved with the proposed solutions, please contact your local EPOS partner for assistance.

To find an EPOS partner in your country, search at eposaudio.com.

Restarting the EXPAND Control

- > Use a paper clip to press the reset button until the option screen appears on the screen.
- > Touch the restart icon.
The EXPAND Control turns off and on again.

1

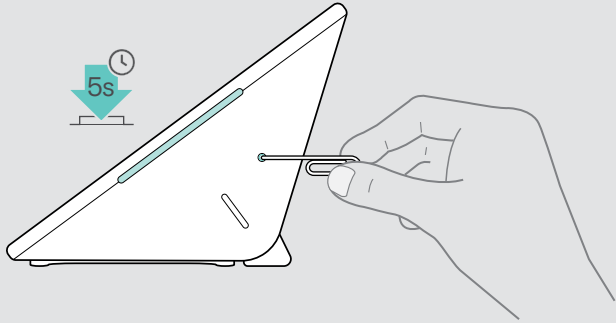

2

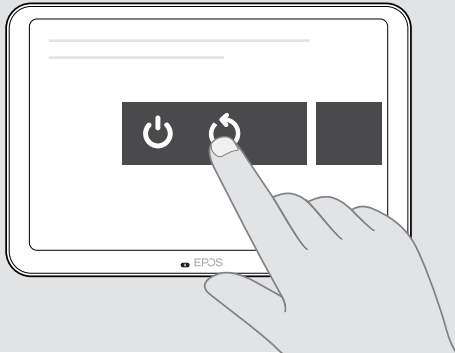

Deleting individual user settings (small reset)

To delete all your settings, e.g. password, room names or language:

- > Enter the **Settings** menu > **Device Settings** > **Debug tools** (enter password, if required) > **Reset user settings**.

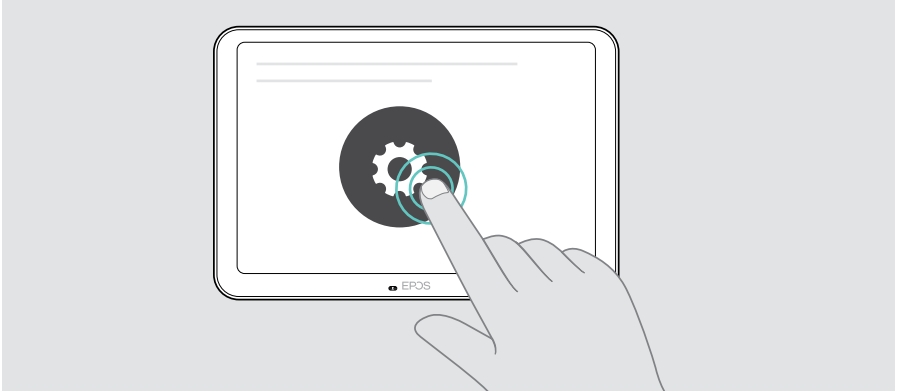

For a full factory reset, contact our customer support.

EPOS



DSEA A/S

Kongebakken 9, DK-2765 Smørum, Denmark

eposaudio.com

Publ. 08/22, A01