

# EPDS

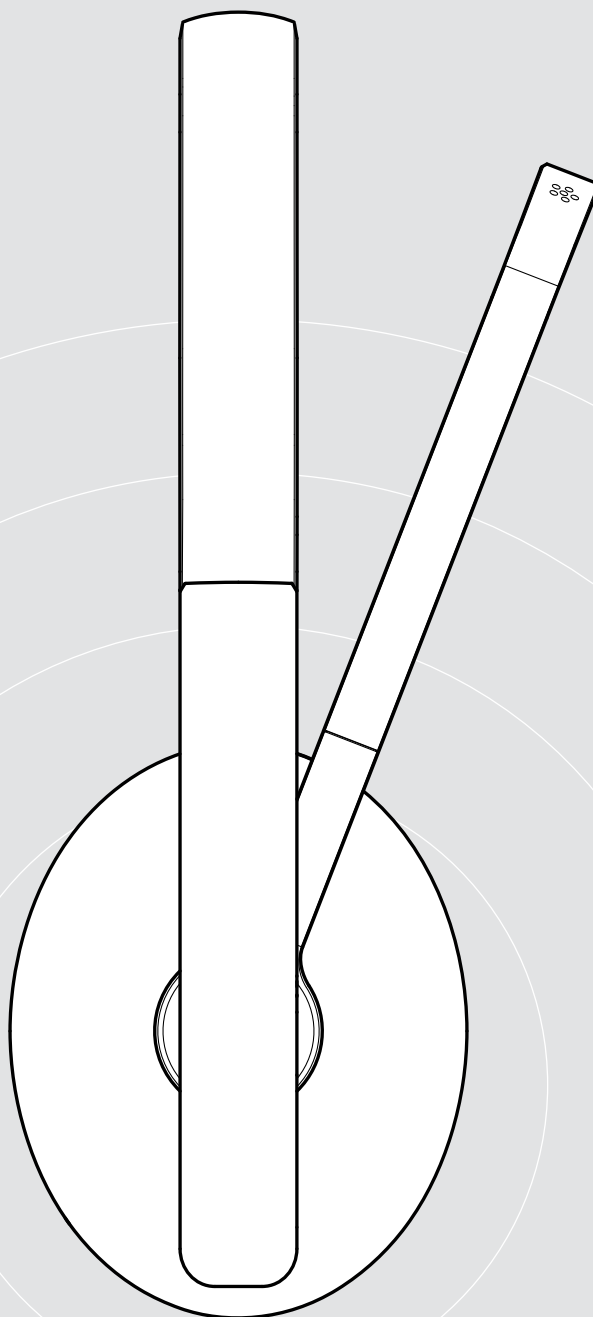
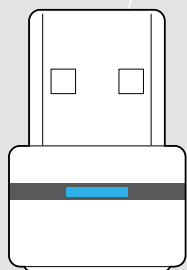

## C20

Wireless Communication Headset certified for Microsoft® Teams

### User Guide

# Contents

Welcome.....	2
Package contents.....	3
Product overview.....	4
Overview of the headset.....	4
Overview of the headset LED indications.....	4
Overview of the headset buttons.....	5
Overview of the icons.....	6
Overview of the dongle.....	7
Overview of the dongle LED indications.....	7
Overview of the dongle button.....	7
Getting started.....	8
Pairing the headset with Bluetooth® devices.....	8
Installing the EPOS Connect app.....	10
Installing the EPOS Connect software.....	10
Changing Audio settings for the headset – Microsoft® Windows.....	10
Using the headset.....	11
Turning the headset on and connecting it.....	11
Turning the headset off.....	11
Adjusting and wearing the headset.....	12
Adjusting the volume.....	13
Adjusting the headset's microphone volume for softphones.....	13
Muting the microphone.....	13
Making calls using the headset.....	14
Making a call.....	14
Accepting / rejecting / ending a call.....	14
Redialing.....	15
Using the voice assistant / voice dial.....	15
Managing multiple calls.....	16
Using headset and dongle with Microsoft® Teams.....	17
Listening to audio using the headset.....	18
Additional functions.....	19
Charging the headset battery.....	19
Verifying remaining battery power.....	19
Storing and transporting the headset.....	20
If you leave the Bluetooth range.....	20
Reconnecting / disconnecting Bluetooth.....	21
Enabling / disabling voice prompts.....	21
Maintaining the products and updating the firmware.....	22
Cleaning the products.....	22
Replacing the ear pads.....	22
Updating the firmware of the products.....	23
If a problem occurs.....	24
Clearing the pairing list of the headset (Reset).....	25
Clearing the pairing list of the dongle (Reset).....	25

# Welcome

## Access peak performance and stay focused

If work or study means communication via multiple devices, choose a wireless headset that fits with your dynamic lifestyle whether it is from home or on-the-go.

Lightweight, portable, and wireless, this flexible audio companion keeps you focused.

The boom arm gets you closer to the conversation and folds easily into the headband for a clean, modern look.

The headset is Microsoft Teams and Zoom certified and UC optimized so you can jump straight into virtual meetings.

## Key benefits & features

### Maximize your comfort and performance

With thick, soft, on-ear leatherette earpads, enabling all-day comfort and passive noise damping.

### Flexible connectivity

Enjoy multi-point connectivity that lets you connect to two devices simultaneously, via Bluetooth® or the USB-A dongle.

### Up to 27 hours battery life

Enjoy up to 27 hours of playback and up to 23 hours of voice calls before recharging.

### Microsoft Teams and Zoom certified and UC optimized

Get a seamless work or study experience with a headset optimized for efficient voice and video calls, certified for Microsoft Teams and Zoom.

### Stay stylish with sleek design

Look stylish at work, school or on-the-go with contemporary design and a boom arm that folds discreetly into the headband.

### Smart and portable to keep you on-the-go

With a smart fold-flat ear cup design and carry pouch, simply pack up and move on to your next work or study task.

### EPOS Audio Technology

EPOS engineered audio delivers clarity, resolution and precision.



For safety instructions, consult the Safety Guide.



For specifications, consult the Fact sheet available at [eposaudio.com](https://eposaudio.com)



A list of accessories can be found on the product page at [eposaudio.com/c20](https://eposaudio.com/c20)

## Trademarks

The Bluetooth® word mark and logos are registered trademarks owned by Bluetooth SIG, Inc. and any use of such marks by DSEA A/S is under license. USB Type-C® and USB-C® are trademarks of USB Implementers Forum. All other trademarks are the property of their respective owners.

## Package contents

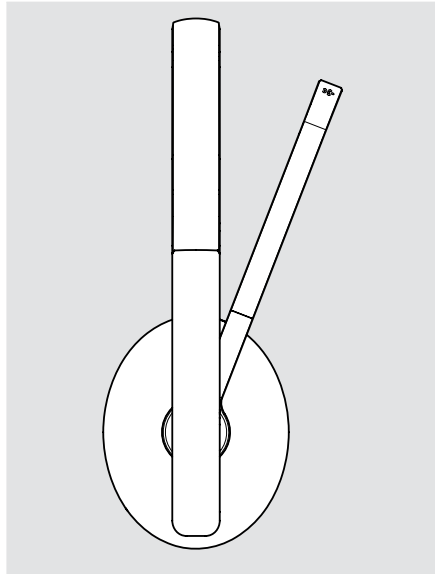

**C20**  
Headset

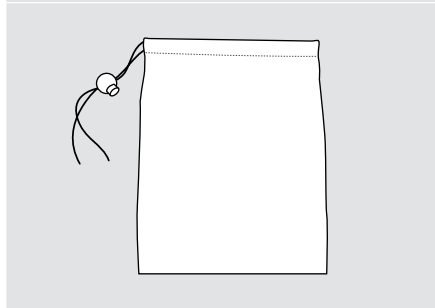

**Carry pouch**

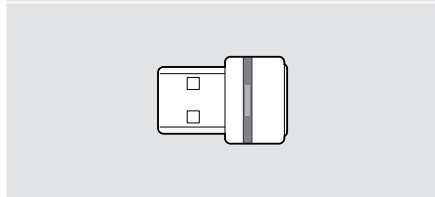

**BTD 800**  
Bluetooth USB dongle

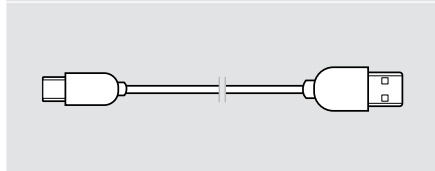

**USB cable**  
with USB-C® to USB-A connector



Quick Guide  
Safety Guide  
Compliance sheet

# Product overview

## Overview of the headset

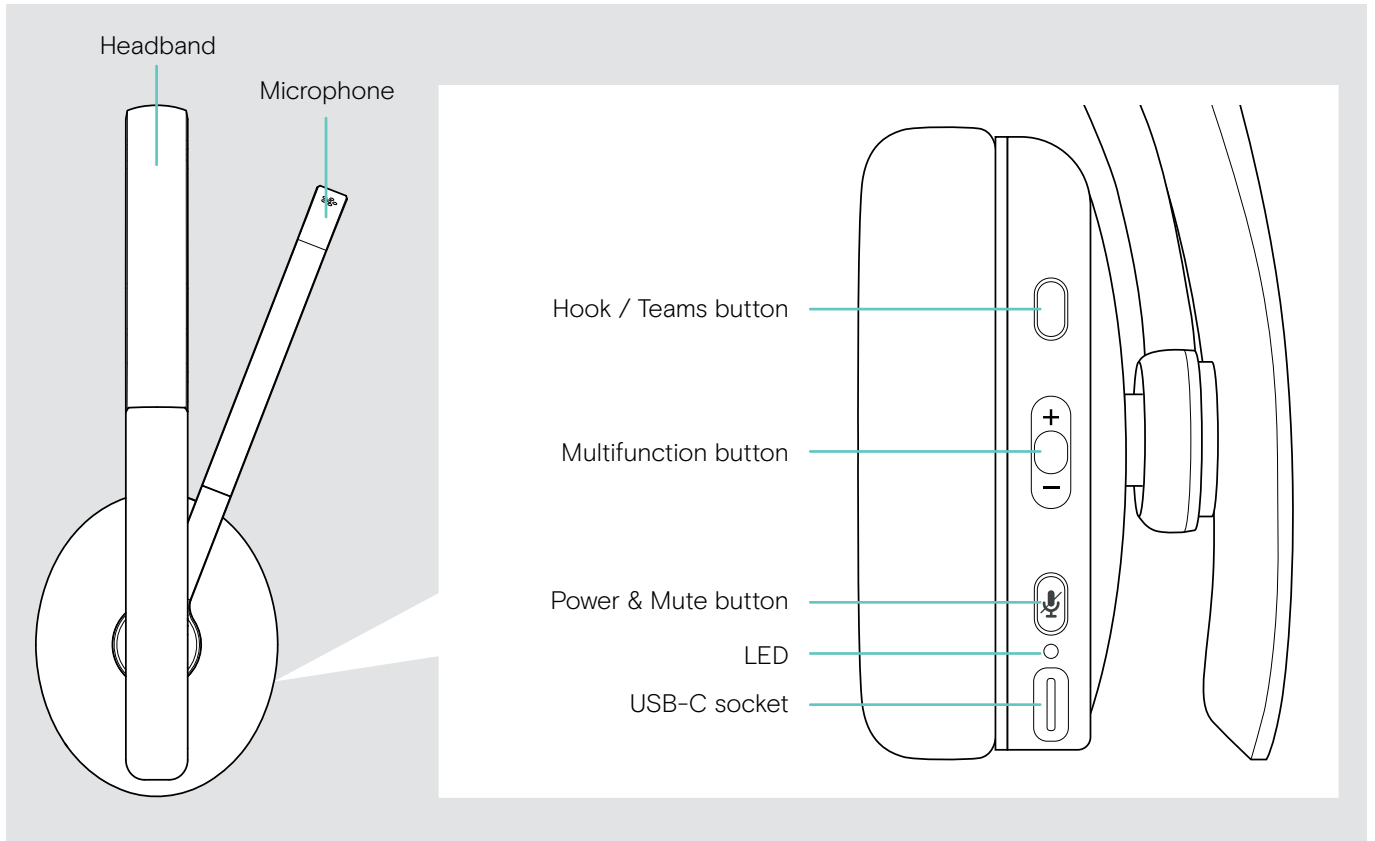

## Overview of the headset LED indications





		<ul style="list-style-type: none"> <li>Headset connected</li> <li>Headset turned off</li> <li>Headset fully charged</li> </ul>
		<ul style="list-style-type: none"> <li>Headset turns on</li> <li>Pairing list cleared</li> </ul>
		<ul style="list-style-type: none"> <li>Bluetooth device found</li> <li>Headset disconnected from mobile device/dongle</li> <li>Bluetooth reconnects</li> </ul>
		Headset in pairing mode: searching for mobile device/dongle*
		Headset turns off
		Incoming call
		Battery power between 61 and 100%
		Battery power between 21 and 60%
		<ul style="list-style-type: none"> <li>Rechargeable battery is weak (&lt; 20%)</li> <li>No Bluetooth device found</li> </ul>

\*Once the headset is successfully connected, the LED goes off.

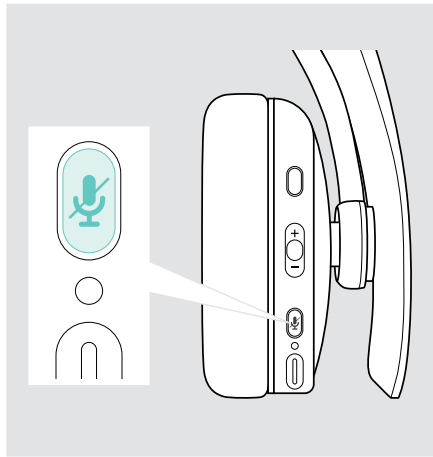
## Overview of the headset buttons









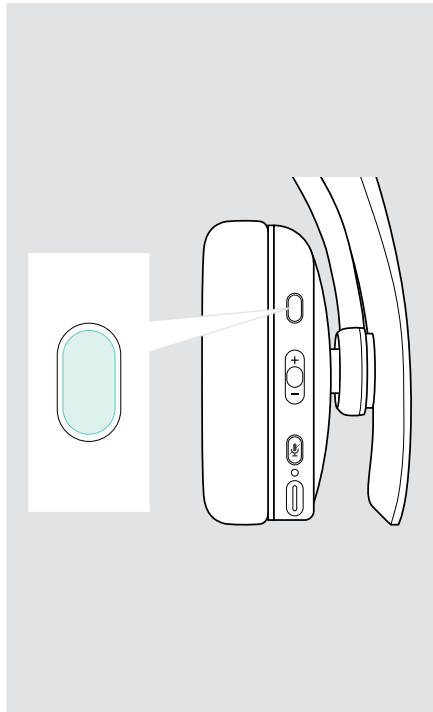



### Power & Mute button







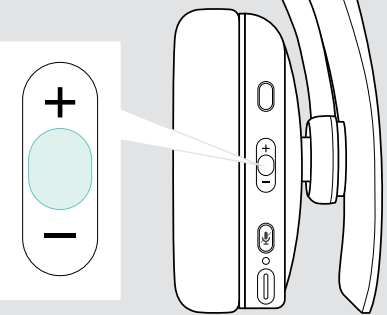
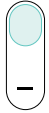

Press	Function	Page
	Turns the headset on / off	11
	Mutes / unmutes the microphone Cancels pairing (Pairing mode)	13 8
	Requests remaining battery power	19
	Pairs the headset with a Bluetooth device Clears pairing list (Pairing mode): Press Power & Multifunction button	8 25

### Hook / Teams button









Press	Function	Page
	Initiates a call	14
	Accepts / ends a call	14
	2 calls: Answers incoming & ends active call	16
	2 calls: Ends active & unholds paused call	16
	Invokes Microsoft Teams	17
	Puts an active call on hold (pause) / unholds call	14
	Redials the last number	15
	2 calls: Answers incoming & puts active on hold	16
	2 calls: Toggles between two calls	16
	Activates voice assistant	15
	Rejects a call	14
	Enables voice prompts: Press Hook & Multifunction button in the direction +	21
	Disables voice prompts: Press Hook & Multifunction button in the direction -	

Multifunction button	Press	Function	Page
		Increases the volume (press or press and hold)	13
		Decreases the volume (press or press and hold)	
		Starts / pauses audio playback	18
		<ul style="list-style-type: none"> <li>Skips to the next track</li> <li>Press and hold: Fast-forwards the track*</li> </ul>	
		<ul style="list-style-type: none"> <li>Skips to the previous track</li> <li>Press and hold: Rewinds the track*</li> </ul>	
		Clears pairing list (Pairing mode): Press Power & Multifunction button	25

\* These functions are not supported by all connected Bluetooth devices.

## Overview of the icons

	Tap the button		Notes: Good to know
	Press the button twice		LED indications
	Press and hold the button		Voice prompt is announced

## Overview of the dongle

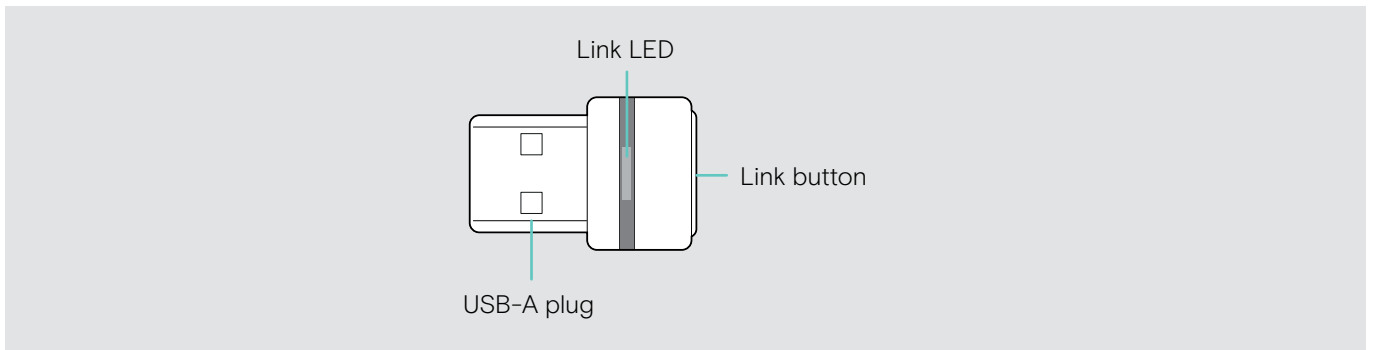

## Overview of the dongle LED indications

	⇒ — — — — — ⇒	Dongle in pairing mode: searching for headset
	3x ⇒ — — — — —	Pairing successful
	3x ⇒ — — — — —	Pairing failed
	⇒ — — — — — ⇒	Dongle tries to connect to a Bluetooth device
	⇒ — — — — —	Dongle and Bluetooth device connected
	⇒ — — — — — ⇒	Incoming call
	⇒ — — — — —	<ul style="list-style-type: none"> <li>Outgoing/active call</li> <li>Audio playback</li> </ul>
	⇒ — — — — —	Connected to Teams
	⇒ — — — — — ⇒	<ul style="list-style-type: none"> <li>Teams notification</li> <li>Connecting to Teams</li> </ul>
	⇒ — — — — — ⇒	Microphone of the connected Bluetooth device is muted

## Overview of the dongle button

Link button	Press	Function	Page
		Pairs the dongle with the headset	8
		Reconnects the headset	21
		Disconnects the headset	21



# Getting started

## Pairing the headset with Bluetooth® devices

**CAUTION**  
**Danger of malfunction!**

- The transmitted radio waves of mobile devices can impair the operation of sensitive and unprotected devices.
- > Only use Bluetooth where it is permitted.

The headset complies with the Bluetooth 5.0 standard. Bluetooth devices need to support the “Hands-Free Profile” (HFP), the “Headset Profile” (HSP), “Audio Video Remote Control Profile” (AVRCP) or the “Advanced Audio Distribution Profile” (A2DP).

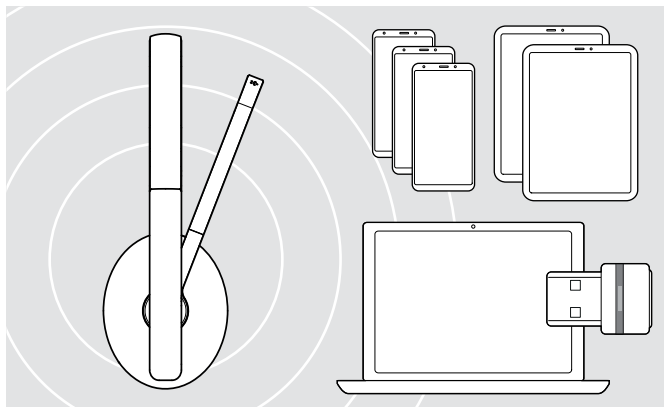

To transmit data via Bluetooth, you first have to pair your headset to a wireless device. The delivered dongle is already paired with the headset.

The headset can save up to eight paired devices. If you pair the headset with a ninth device, the device with the oldest activity in the pairing list will be overwritten. If you want to re-establish a connection with this device, you have to pair it again.

The headset can be connected to two of the paired devices at the same time. You can only connect another device by disconnecting one of the already connected devices.

### Connecting the headset via the dongle

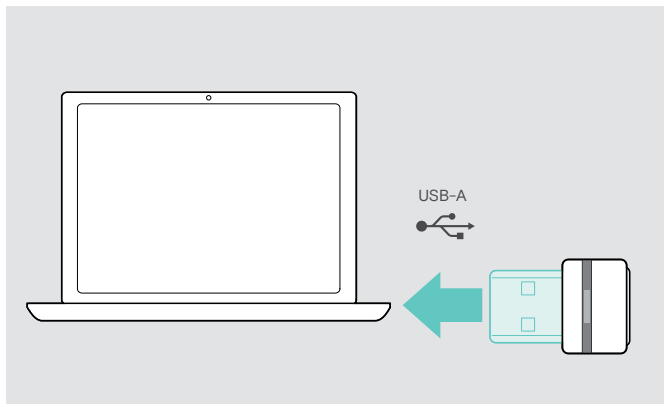

To connect the headset wirelessly with a computer, use the BTD 800 dongle.

The dongle and the headset are already paired.

- > Turn the headset on (see page 11).
- > Plug the dongle into the USB port of your computer.

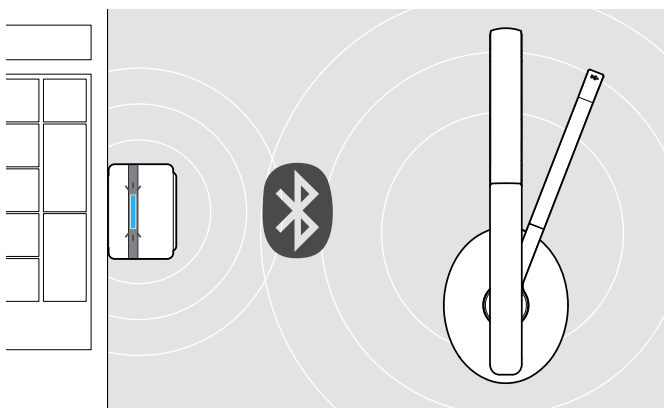

The dongle LED flashes blue while searching and switches to dimmed blue when connected successfully to the headset.

3x

If Microsoft Teams is invoked: The dongle connects to Teams and lights up purple instead of blue.

The dongle shows Teams notifications (see page 17).

**i** To manually pair the headset and the dongle, activate the pairing mode for both:  
 > Press and hold the headset’s Power button and the dongle’s button until the LEDs alternately flashes blue and red. Once the dongle and the headset are connected, the dongle lights up dimmed blue.

### Pairing the headset via Bluetooth with a mobile device

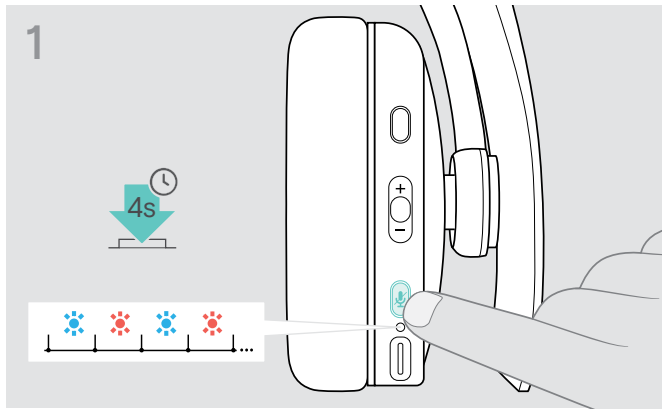

- > Press and hold the Power button until the LED flashes blue and red. The headset is in pairing mode.

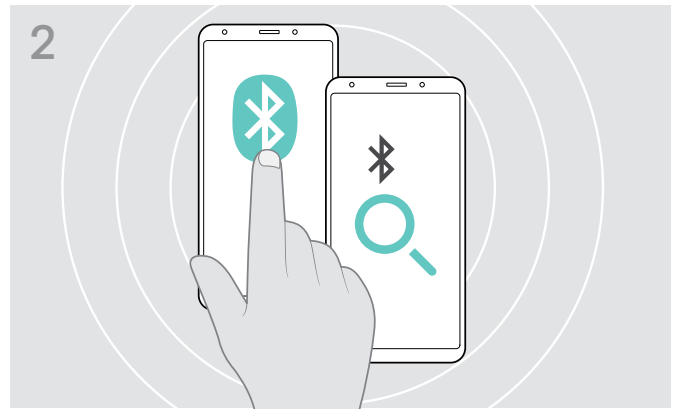

- > Enable Bluetooth on your mobile device and start the search for Bluetooth devices – see instruction manual of your mobile device.



- > Select “EPOS C20” to establish a Bluetooth connection to the headset.

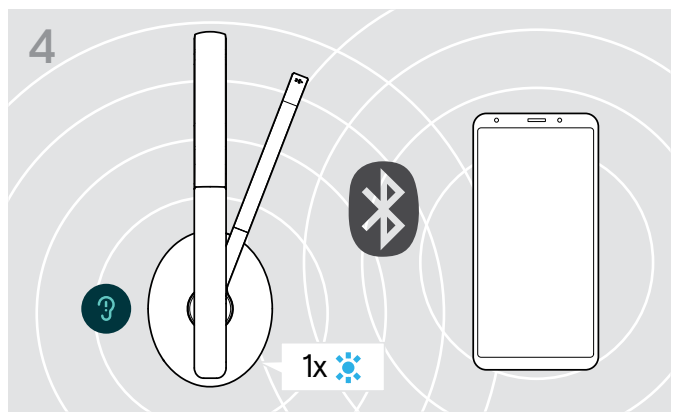

- As soon as the headset finds a device to connect to, the LED lights up blue shortly and turns off.



To cancel pairing:

- > Press the Power button.

## Installing the EPOS Connect app



The free **EPOS Connect app** allows you to configure your headset and offers additional settings.

- > Open the App Store or Google Play app on your mobile device.
- > Search for "EPOS Connect".
- > Download and install the app.

## Installing the EPOS Connect software

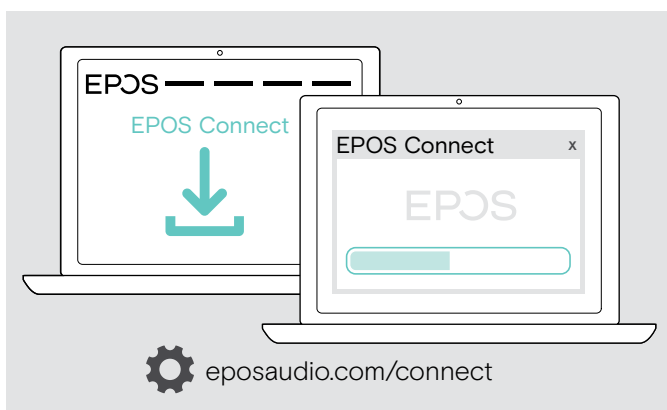

The free **EPOS Connect software** allows you to configure and update your headset and offers additional settings.

- > Download the software from [eposaudio.com/connect](https://eposaudio.com/connect).
- > Install the software.

You need administrator rights on your computer.

To make calls via the computer:

- > Install a softphone / VoIP software application.

## Changing Audio settings for the headset – Microsoft® Windows

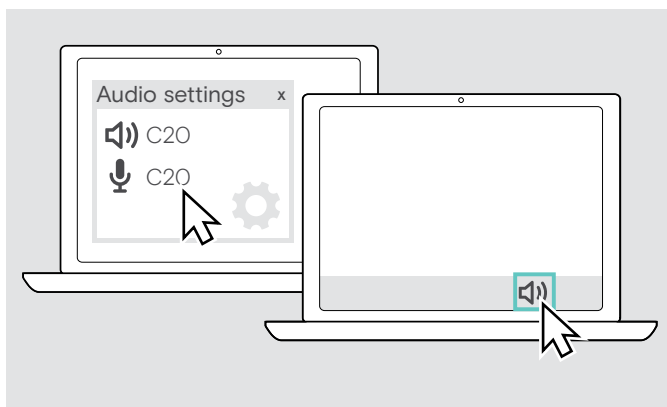

Windows usually changes the Audio settings automatically if you connect a new headset.

If the headset is connected but you hear no sound:

- > Right-click the Audio icon.
- > Select under output C20 as speaker.
- > Select under input C20 as microphone.

## Using the headset



### CAUTION

#### Hearing damage due to high volumes!

Listening at high volume levels for long periods can lead to permanent hearing defects.

- > Set the volume to a low level before putting on the headset.
- > Do not continuously expose yourself to high volumes.

## Turning the headset on and connecting it

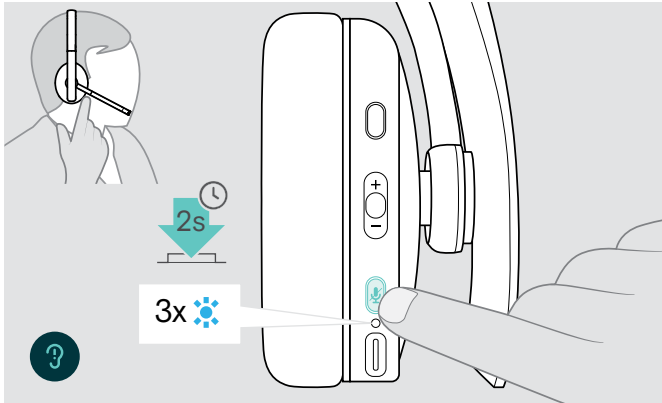

- > Press the Power button for 2 seconds. The headset turns on. The LED flashes blue shortly. The headset automatically tries to connect to available paired Bluetooth devices.

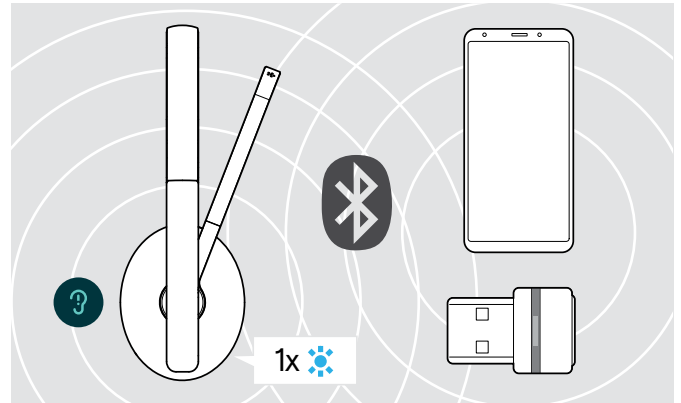

As soon as the headset finds a device to connect to, the LED lights up blue shortly and turns off.

If the LED flashes red, no paired device has been found.



The search function is deactivated while the audio cable is connected.

## Turning the headset off

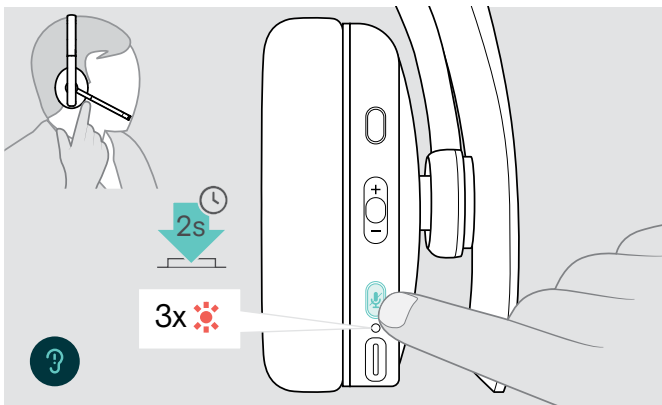

- > Press the Power button for 2 seconds. The LED flashes red 3 times and turns off. All volume settings are saved automatically when the headset is turned off.
- > Charge the headset (see page 19).  
OR
- > Store the headset (see page 20).

## Adjusting and wearing the headset

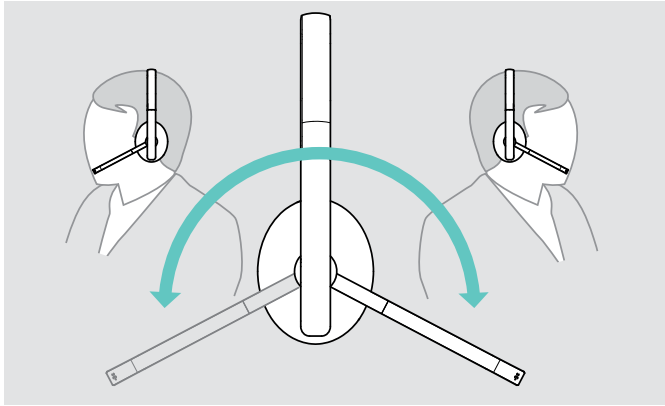

> Rotate the microphone boom.

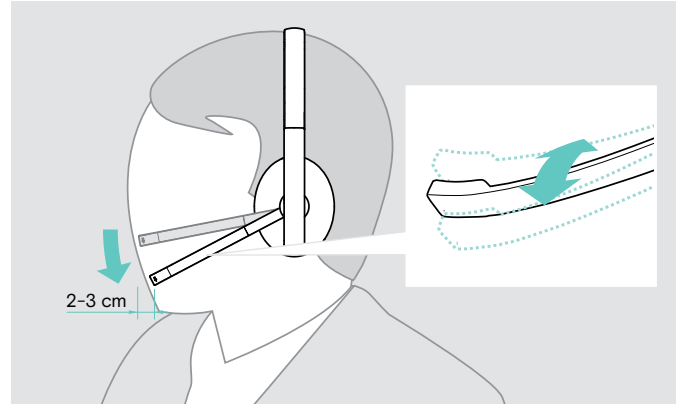

- > Bend the microphone boom so that the microphone is about 0.8" (2 cm) from the corner of your mouth.
- > Adjust the headset so that the ear pads rest comfortably on your ears.

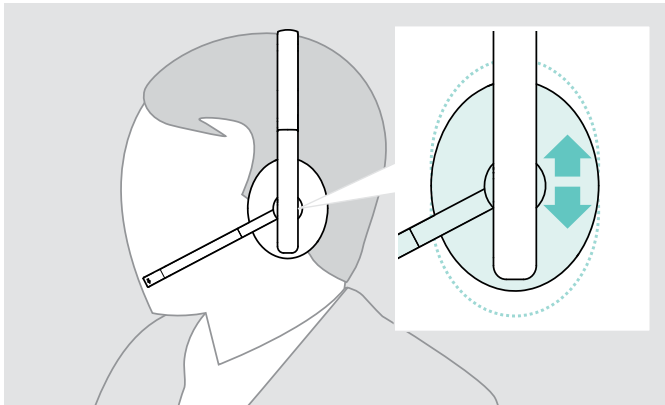

## Adjusting the volume

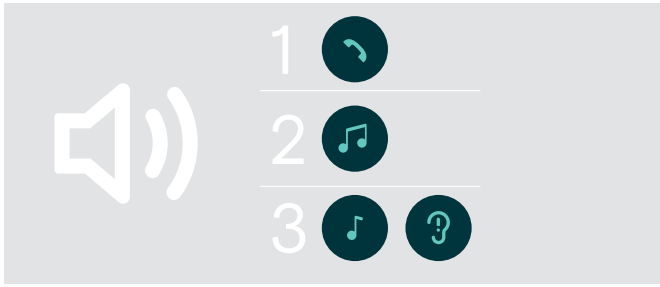

You can adjust three independent volume settings for the headset:

1. Call volume: during an active call
2. Audio volume: during audio streaming
3. Volume for ring tone, tones and voice prompts: in idle mode – no active call or audio streaming

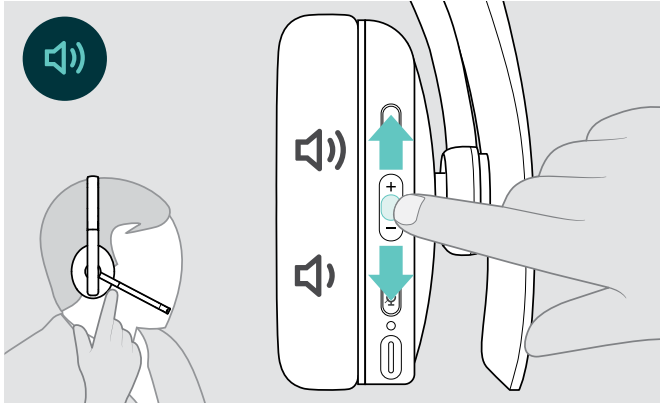

- > Press the Volume button to increase or decrease the volume. You hear a beep or double beep for maximum or minimum volume.

Alternatively you can adjust the volume on your connected device.

## Adjusting the headset's microphone volume for softphones

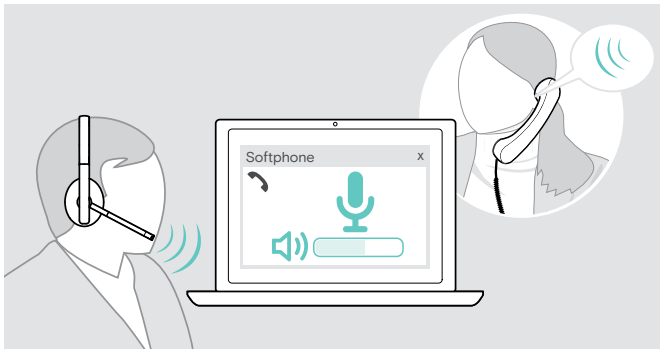

- > Initiate a call on your connected device to someone who will help you find the correct volume setting for your microphone.
- > Change the microphone volume in your softphone application and/or in your PC audio application.

## Muting the microphone

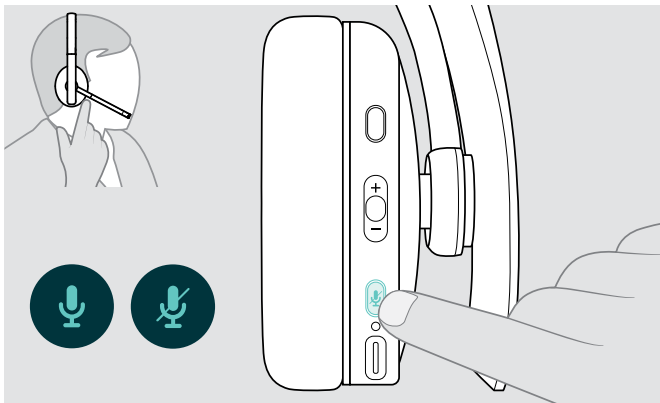

- > Press the Mute button to

---

 mute or

---

 unmute the microphone.

---

## Making calls using the headset

The following functions depend on the connected device.

### Making a call



- > Initiate the call on your connected device.  
OR
- > Press the Hook button to initiate a call via your softphone.

If your call is not automatically transferred to the headset:

- > Search this function in the instruction manual of your connected device.



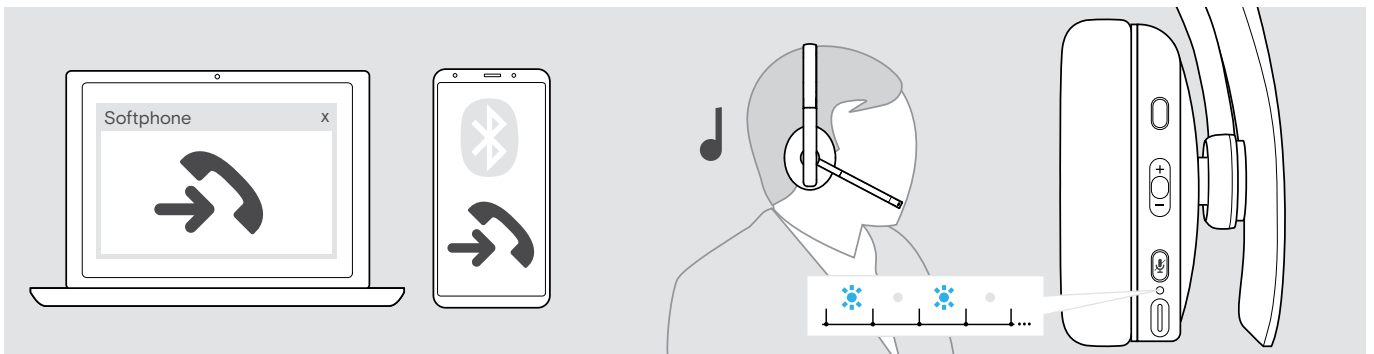

### Accepting / rejecting / ending a call

When you receive a call, you hear a ring tone and the LED flashes blue.

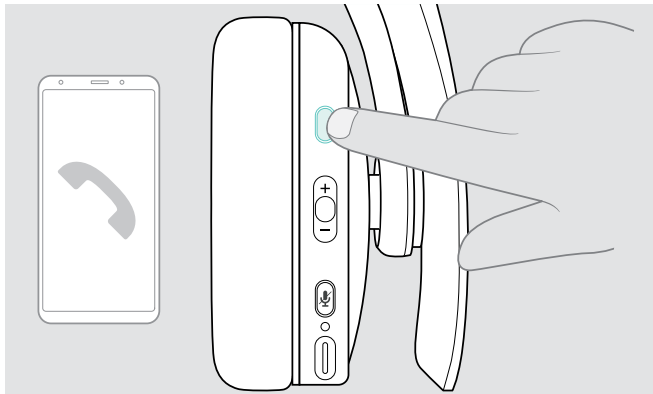





#### Accept / hold a call

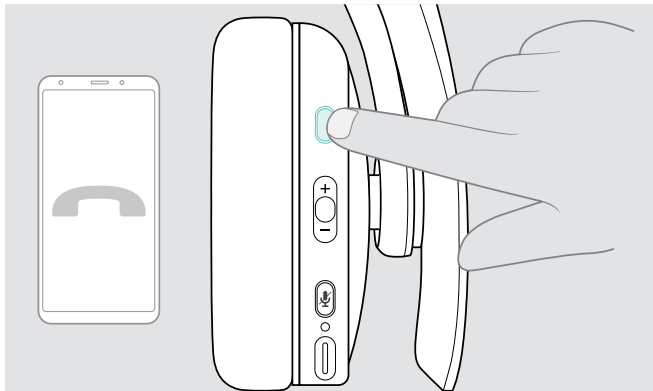

		Accepts a call
		Puts an active call on hold (pause)





#### Reject / end a call

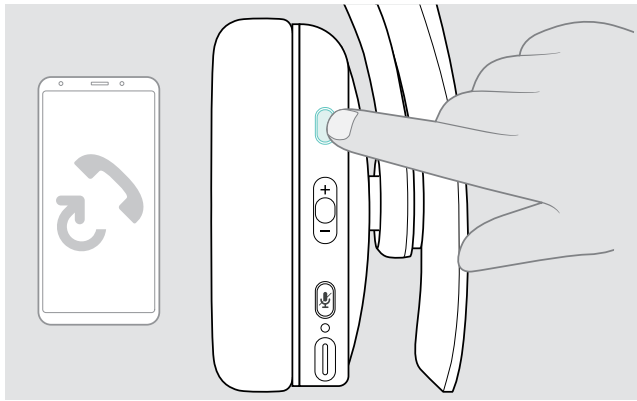

		Rejects a call
		Ends a call

## Redialing





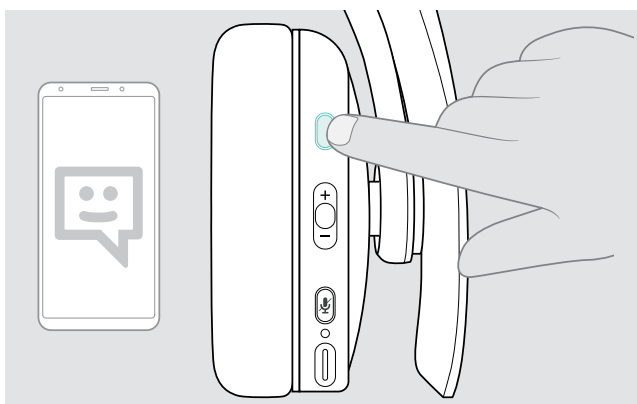

		Redials the last number
		Cancels redialing

## Using the voice assistant / voice dial

The last connected Bluetooth device will be used for voice assistant or voice dial.



		Activates voice assistant / voice dial
		Cancels voice assistant / voice dial



## Managing multiple calls



You can use the headset with up to two connected Bluetooth devices.

Two calls can be managed simultaneously.

If you receive a call during an active call, a knock on tone will be played.

### Accept / reject second call

Active call	2nd incoming call	Action
		Accepts the incoming call and ends the active call
		Accepts the incoming call and puts the active call on hold
		Rejects the incoming call and continues the active call

### Toggle between calls / end active call

Active call	2nd held call	Action
		Toggles between the active and held call
		Ends the active call and makes the held call active

## Using headset and dongle with Microsoft® Teams

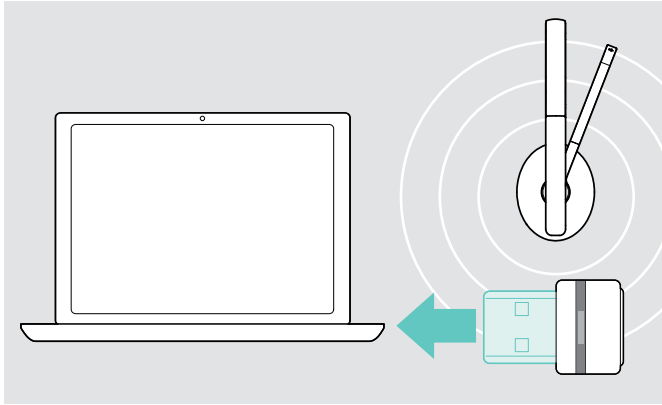

To use Microsoft Teams with the headset:

- > Plug the dongle into the USB port of your computer – see page 8.
- If Microsoft Teams is already running, the blue LED changes to purple automatically.

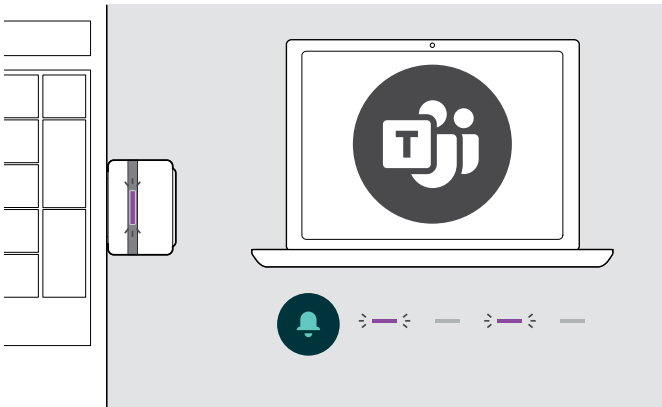

To invoke Microsoft Teams and check notifications:

- > Start Microsoft Teams on your computer.
- The dongle connects to Microsoft Teams and the LED blue LED changes to purple.



The LED pulses purple to indicate:

- Meeting Join Notification
- Voice Mail Notification
- Missed Call Notification

To check these Notifications on your screen:









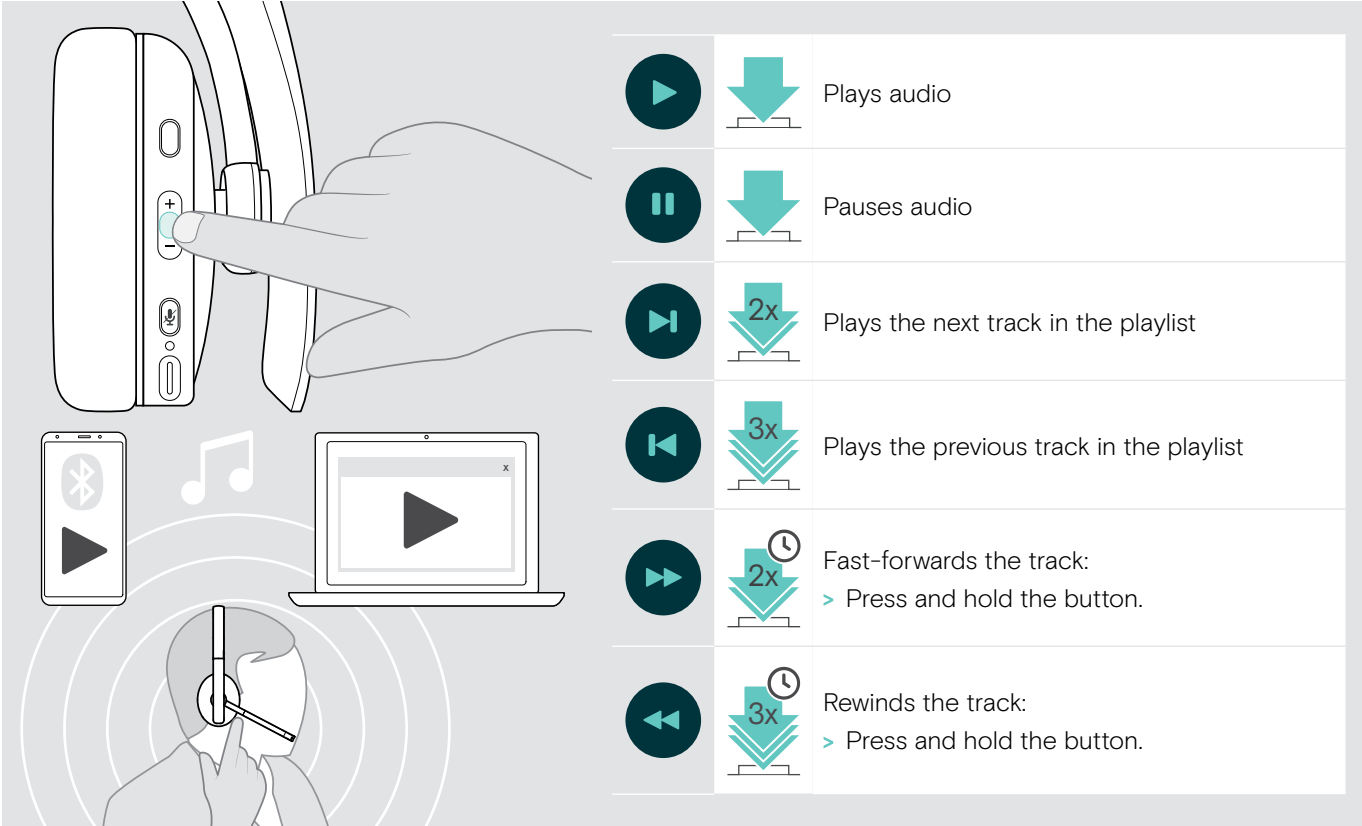



- > Press the Teams button.

## Listening to audio using the headset

You can listen to audio via a connected device. The following functions depend on the connected device.

- > Play the media on your connected Bluetooth device.  
The LED on the dongle lights up blue.



		Plays audio
		Pauses audio
		Plays the next track in the playlist
		Plays the previous track in the playlist
		Fast-forwards the track: > Press and hold the button.
		Rewinds the track: > Press and hold the button.



If you receive and accept a call, audio playback is paused and restarts after the call – if supported by the connected device.

## Additional functions

### Charging the headset battery

> Connect the supplied USB cable to the USB socket of the headset and a USB socket of your computer.

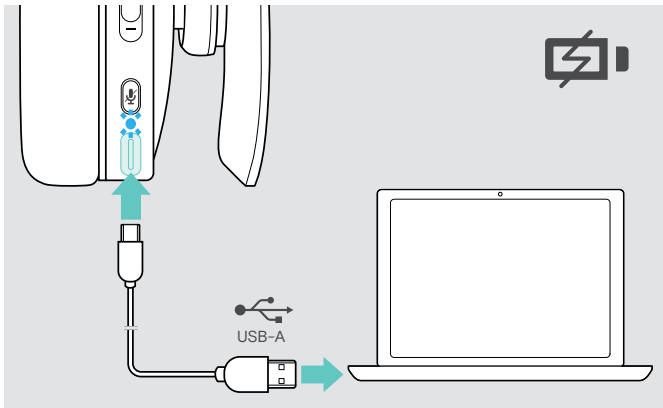

The battery is being charged. The LED lights up depending on the battery status of the headset and turns off when the battery is fully charged.

LED	Battery status
	100% - Battery fully charged
	more than 61%
	more than 21%
	less than 21%

To end charging:

> Disconnect the USB cable from the headset.



When the battery is flat, the headset turns off automatically.

### Verifying remaining battery power

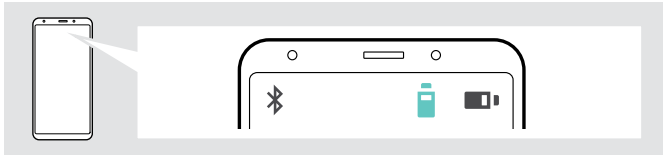

Some mobile devices indicate the battery status of the headset.

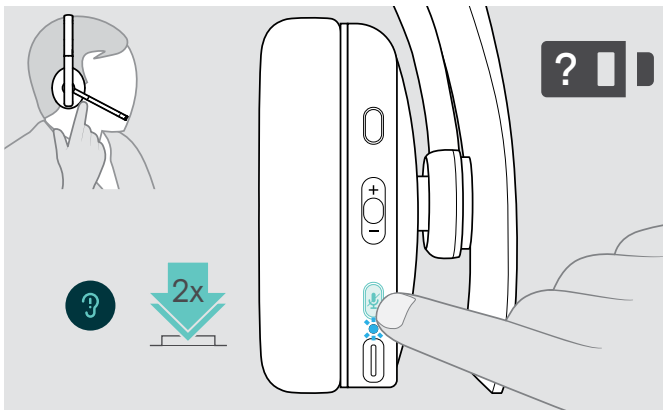

You can retrieve information on the remaining battery power at any time – except while you are in a call:

> Press the power button twice.  
The LED flashes shortly and a voice prompt is announced.



When the battery power drops below 21%, the LED flashes red and “Recharge headset” is announced several times.

LED	Remaining battery power
	more than 61%
	more than 21%
	less than 21% – automatic voice prompt

## Storing and transporting the headset

To avoid nicks or scratches on the headset:

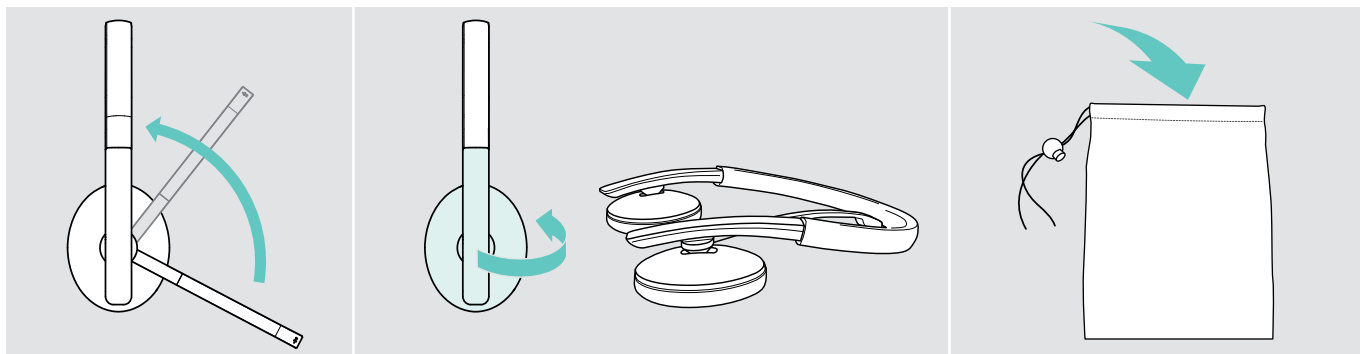

- > Rotate the microphone boom so that it disappears underneath the headband.
- > Fold the ear cups inwards.
- > Store the headset in the pouch when not in use or when carrying it around. Keep it in a clean and dry environment.

If you do not use the headset for extended periods of time:

- > Charge the built-in rechargeable battery every 3 months for about 1 hour.

## If you leave the Bluetooth range

The range between headset and Bluetooth device is device dependent. The transmission range largely depends on environmental conditions such as wall thickness, wall composition etc. With a free line of sight, the transmission range of most Bluetooth devices is up to 25 meters.

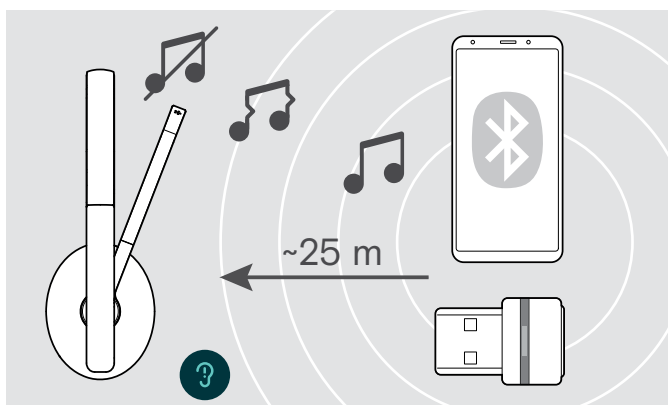

If the audio quality deteriorates e. g. during a call or the link breaks down completely:

- > Re-enter the radio range of the Bluetooth device.

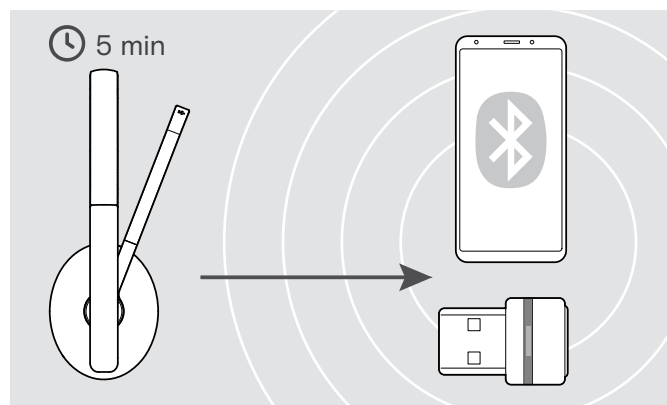

If you re-enter the Bluetooth transmission range **within 5 minutes**, the connection is re-established.

After **more than 5 minutes** the connection breaks down completely and you have to manually re-establish the connection:

- > Tap the Power button.

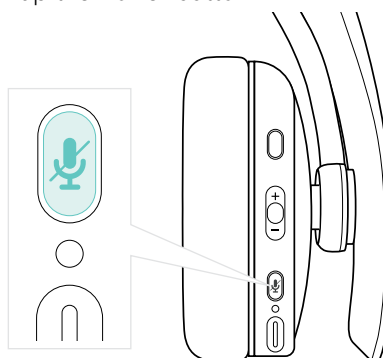

## Reconnecting / disconnecting Bluetooth

### Reconnecting Bluetooth

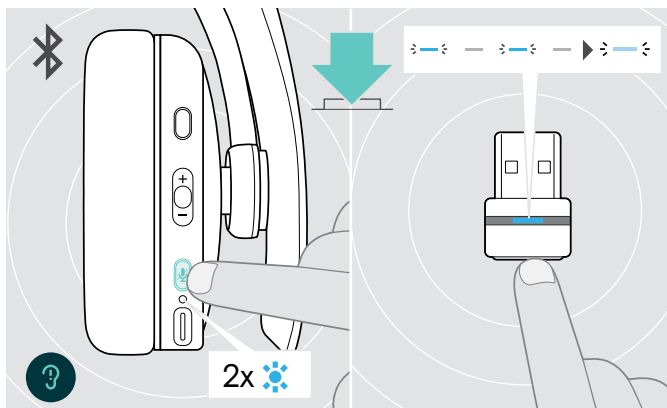

- > Tap the headset's Power button or the dongle's button. The headset flashes 2 times blue as soon as the headset finds a device to connect to. The dongle flashes blue and lights up dimmed blue.

### Disconnecting Bluetooth

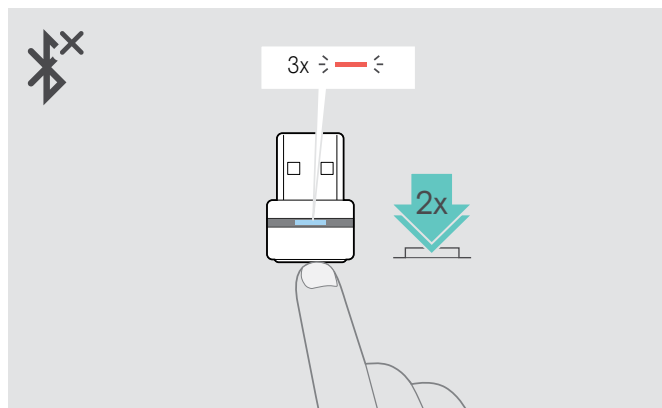

- > Double tap the dongle's button. Bluetooth will be disconnected. The LED flashes 3 times red.

## Enabling / disabling voice prompts

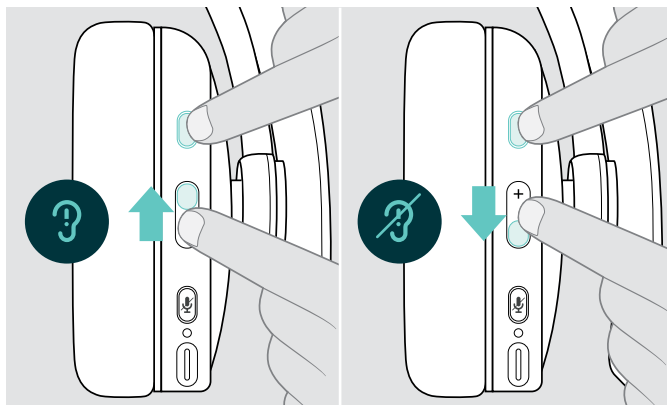

In idle mode (no active call or audio playback):

- > Press the Hook & Multifunction button
  - in the direction +, to enable or
  - in the direction -, to disable the voice prompts.
 The corresponding voice prompt is announced.



If the voice prompts are deactivated you hear tones instead.

# Maintaining the products and updating the firmware

## Cleaning the products

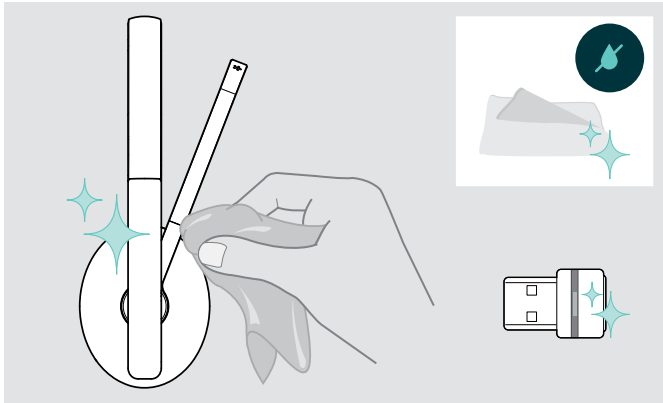

### CAUTION

#### Liquids can damage the electronics of the product!

Liquids entering the housing of the device can cause a short circuit and damage the electronics.

- > Keep all liquids far away from the product.
- > Do not use any cleansing agents or solvents.
- > Only use a dry cloth to clean the product.

## Replacing the ear pads

For hygienic reasons, you should replace the ear pads from time to time. Spare ear pads are available from your EPOS partner.

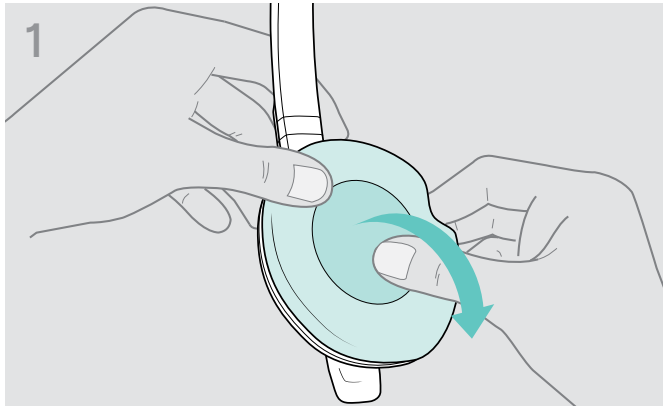

- > Carefully remove the old ear pad from the ear cup.

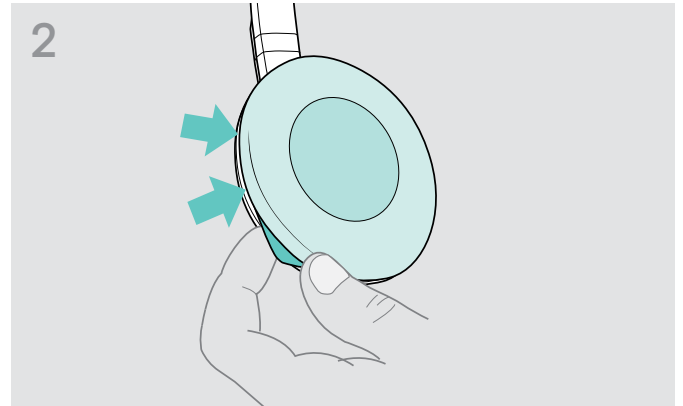

- > Secure the new ear pad by inserting the fixation band in the space on the ear cup.

## Updating the firmware of the products

To update the installed firmware:

- > Install the free of charge **EPOS Connect** software (see page 10).

### Updating the firmware of the headset

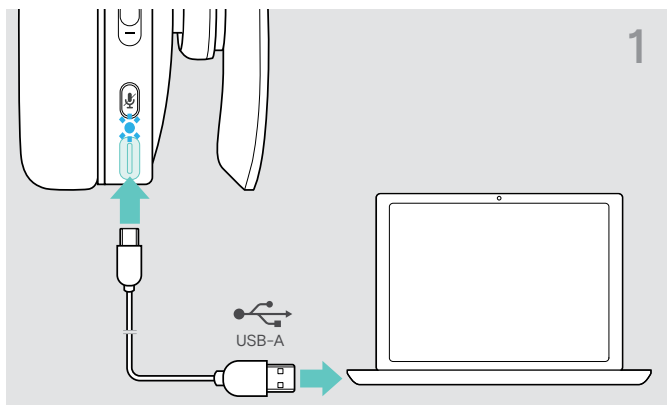

- > Connect the USB cable to your headset and your computer.  
The LED lights up.



### Updating the firmware of the dongle

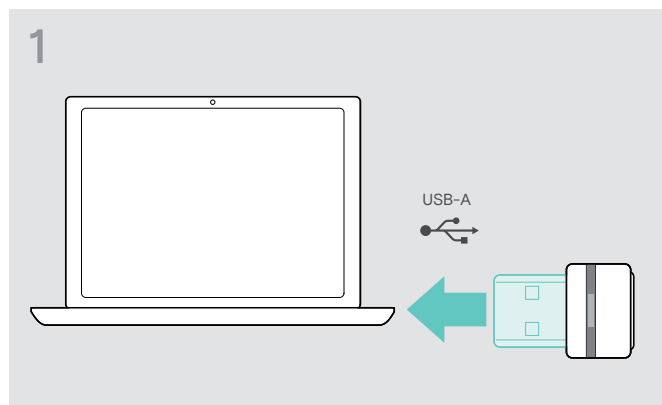

- > Plug the dongle into the USB port of your computer.  
The LED lights up.
- > Start **EPOS Connect**.  
If there is a new firmware available the software will guide you through the update process.



## If a problem occurs ...

Problem	Possible cause	Solution	Page
Headset cannot be turned on	Rechargeable battery empty	> Recharge the headset battery.	19
No audio signal or drop outs	Headset not paired with a Bluetooth device	> Pair the headset.	8
	Volume adjusted too low	> Increase the volume.	13
	Headset turned off	> Turn the headset on.	11
	Computer: Headset not selected as audio device	> Change the Audio settings of your computer.	10
Headset cannot be connected via Bluetooth	Headset not paired	> Pair the headset with a Bluetooth device (max. 20 cm distance while pairing between devices).	8
		> Check if your Bluetooth device supports the HF or HS profile.	-
	Bluetooth at mobile device turned off	> Turn Bluetooth on.	-
	Dongle not plugged in	> Plug the dongle into the USB port of your computer.	8
Microsoft Teams does not work: LED blue instead of purple	Dongle or Microsoft Teams disturbed	> Unplug and plug the dongle again.	-
		> Re-start Teams on your device.	-
Beeps instead of voice prompts	Voice prompts disabled	> Enable the voice prompts.	21
Headset or dongle does not react to any button press	Software or hardware problems	> Turn the headset off and on again.	11
		> Unplug and plug in the dongle again.	8
		> Clear the pairing list of the headset.	25
		> Clear the pairing list of the dongle.	25

If a problem occurs that is not listed in the above table or if the problem cannot be solved with the proposed solutions, please contact your local EPOS partner for assistance.

To find the EPOS partner in your country, search at [eposaudio.com](https://www.eposaudio.com).

## Clearing the pairing list of the headset (Reset)

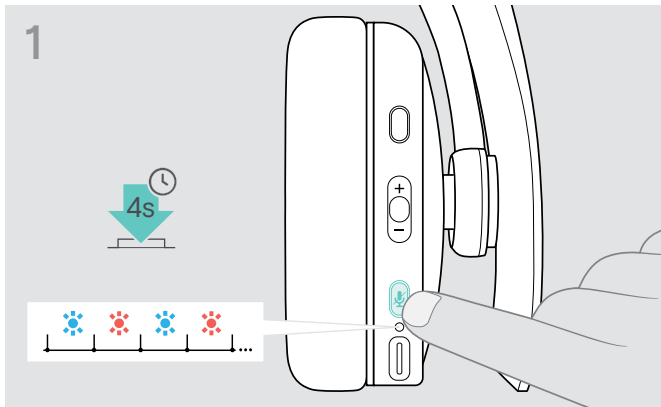

- > Press and hold the Power button until the LED flashes blue and red.

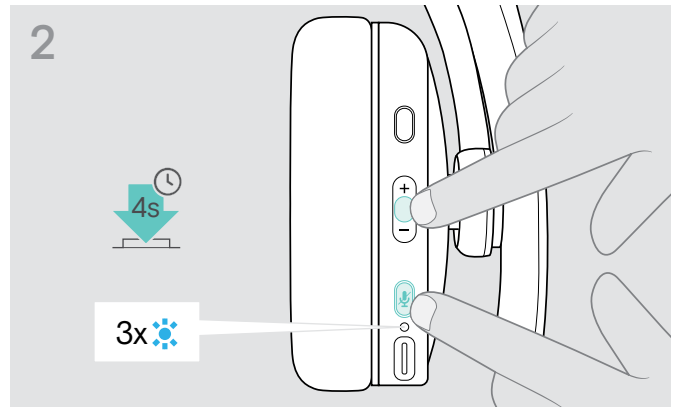

- > Simultaneously press and hold the Multifunction button and the Power button for 4 seconds. The LED flashes blue 3 times. The pairing list is cleared. The headset searches for Bluetooth devices to pair with – see page 8.

## Clearing the pairing list of the dongle (Reset)

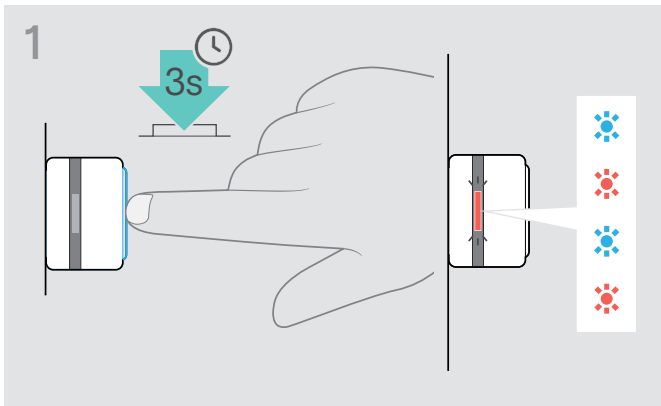

- > Plug the dongle into the USB port of your computer.
- > Press and hold the button until the LED flashes blue and red.

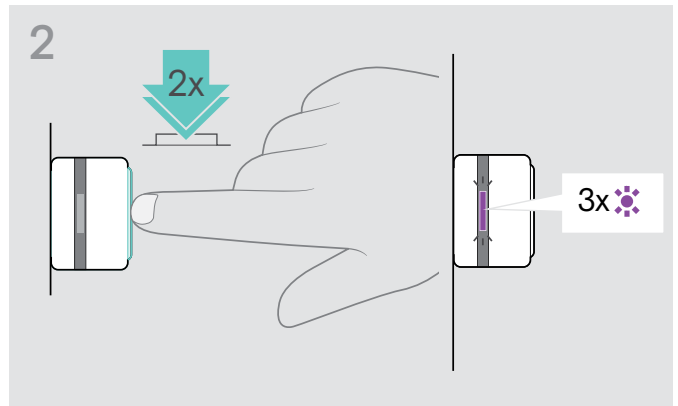

- > Double press the dongle's button. The LED flashes purple 3 times. The pairing list is cleared. The dongle searches for Bluetooth devices to pair with – see page 8.

# EPOS

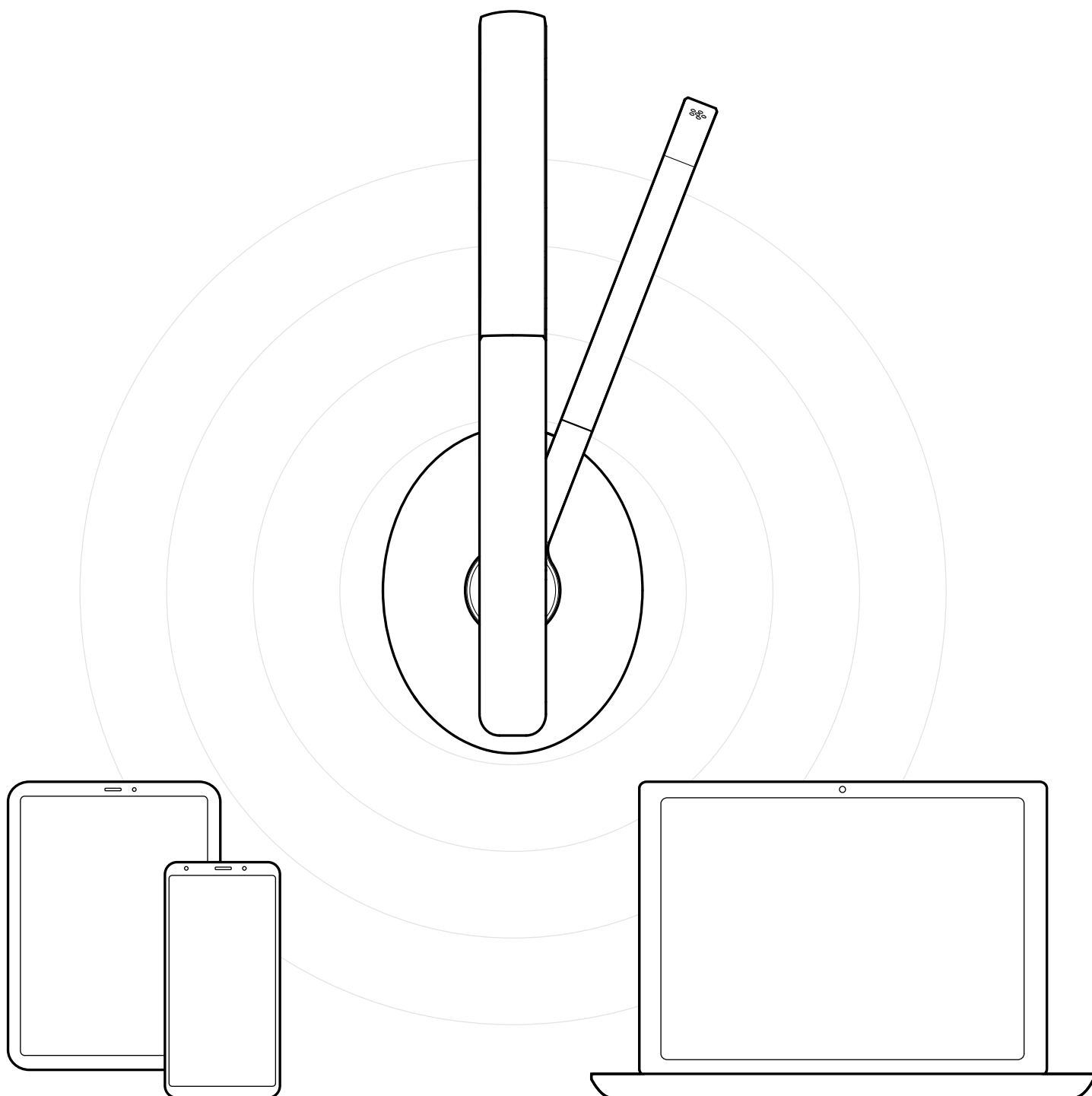

DSEA A/S

Kongebakken 9, DK-2765 Smørum, Denmark  
eposaudio.com

Publ. 02/23, A03